

24013

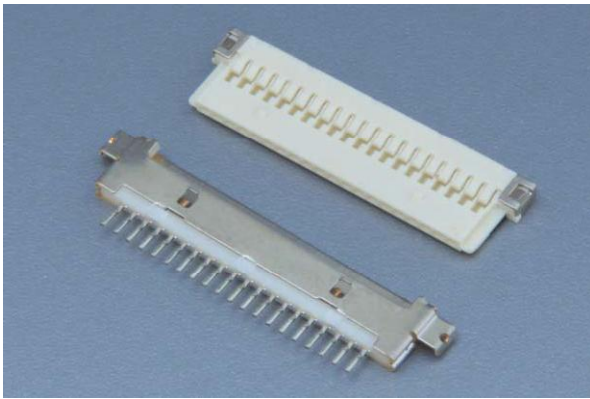

Pitch 1.0mm Wire to Board Connectors - SMT Type



PERFORMANCE

Electrical Rating: AC/DC 100V 0.3A
 額定電壓電流
 Insulation Resistance: 500MΩ min.
 絕緣阻抗
 Withstanding Voltage: 300V AC/minute
 耐電壓
 Temperature Range: -35°C~+85°C
 適用溫度



1.0mm

CONNECTOR - Through Hole

Part No.: MSB24013P20

產品編號

Material: Housing: Nylon 94V-0

材質 塑膠座 尼龍

Contact Pin: Phos, half gold-tin plated

接觸針 磷青銅, 鍍半金錫

Reinforcement: Stainless Steel

補強片 不銹鋼

Packing: 2,000pcs/Reel

包裝數量 捲

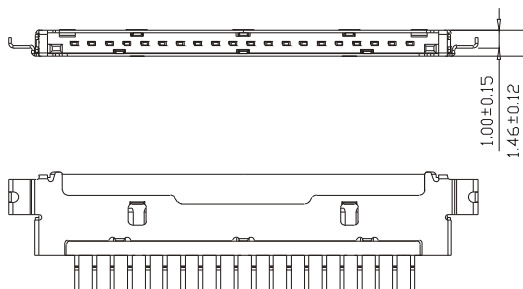
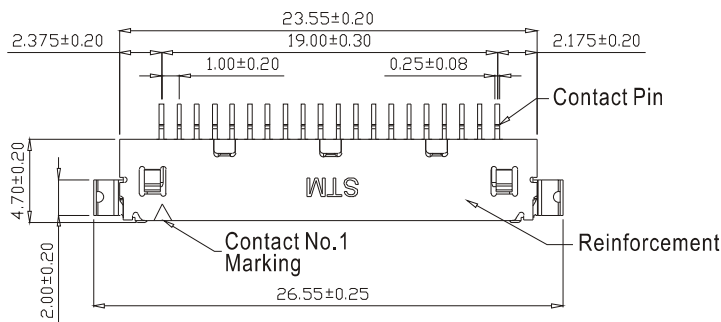
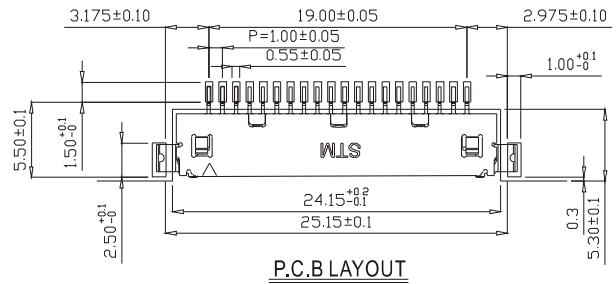
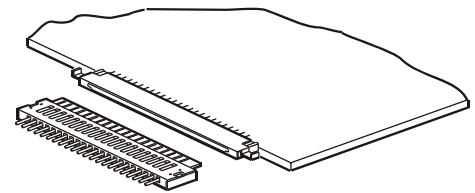

Behave in conformity with continual product development policy, Sin Sheng (STM) reserves the right of specification changing of contents described in this catalogue at any time and without prior notice. Please contact the sales department nearby for most updated information.
 由於產品持續開發的政策, 信盛(STM)保留隨時變更本目錄所述之規格且不需提前通知的權利, 請逕繫業務處查詢最新的產品資訊。

24013 Wire to Board Connectors

CONNECTOR - Through Hole

Part No.: **MSB24013P20 RF:A**

產品編號

Material: Housing: Nylon 94V-0

材質 塑膠座 尼龍

Contact Pin: Phos, half gold-tin plated

接觸針 磷青銅, 鍍半金錫

Reinforcement: Stainless Steel

補強片 不銹鋼

Packing: 2,000pcs/Reel

包裝數量 捲

PERFORMANCE

Electrical Rating: AC/DC 100V 0.3A

額定電壓電流

Insulation Resistance: 500MΩ min.

絕緣阻抗

Withstanding Voltage: 300V AC/minute

耐電壓

Temperature Range: -35°C ~ +85°C

適用溫度



1.0mm

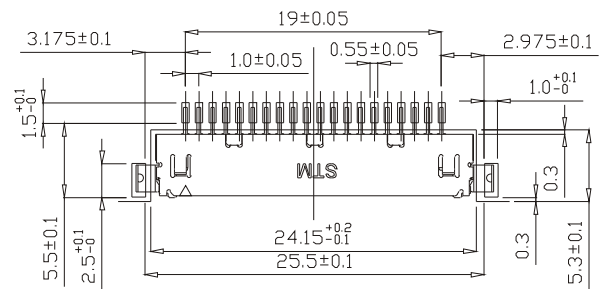

P.C.B LAYOUT

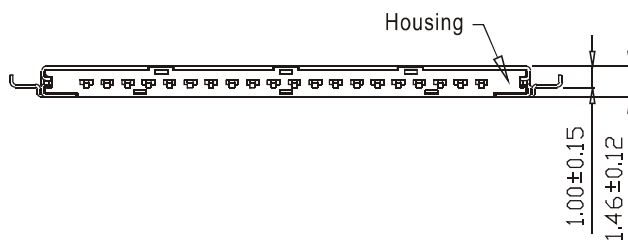
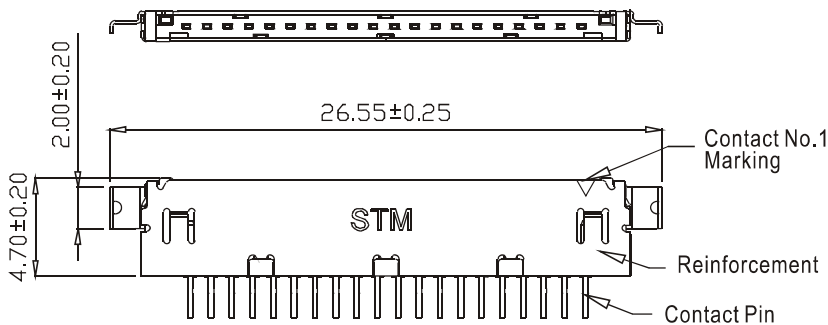
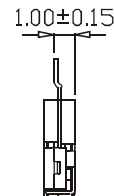
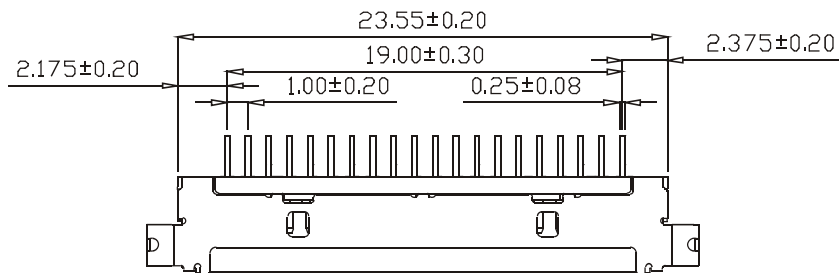

24013 Wire to Board Connectors

CONNECTOR - Through Hole

Part No.: **MSB24013P20 RF:HA**

產品編號

Material: Housing: Nylon 94V-0

材質 塑膠座 尼龍

Contact Pin: Phos, half gold-tin plated

接觸針 磷青銅, 鍍半金錫

Reinforcement: Stainless Steel

補強片 不銹鋼

Packing: 2,000PCS(Reel)

包裝數量

PERFORMANCE

Electrical Rating: AC/DC 100V 0.3A

額定電壓電流

Insulation Resistance: 500MΩ min.

絕緣阻抗

Withstanding Voltage: 300V AC/minute

耐電壓

Temperature Range: -35°C~+85°C

適用溫度



1.0mm

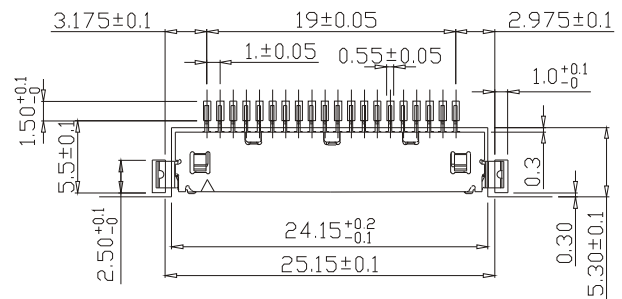

P.C.B LAYOUT

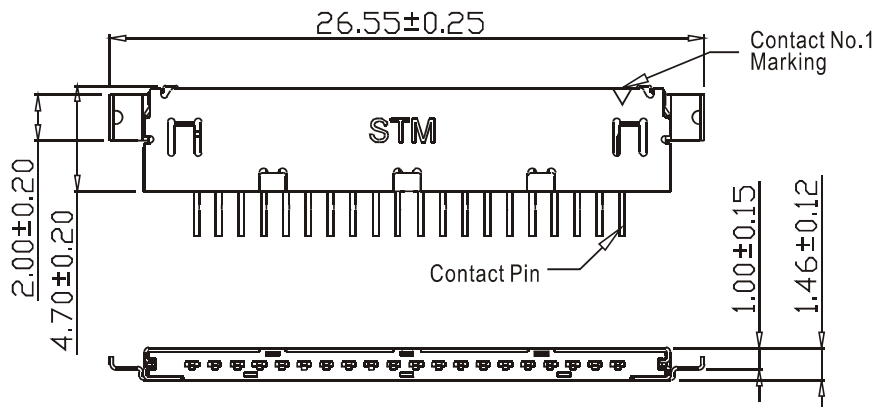
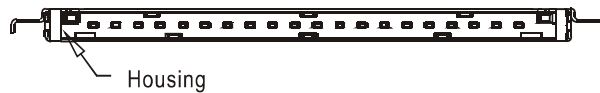
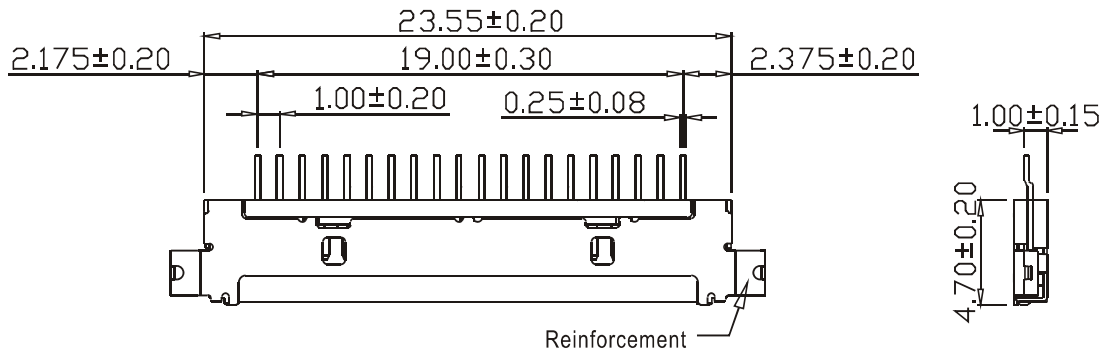

24013 Wire to Board Connectors - SMT Type

Embossed Carrier Tape Dimensional Drawing

MSB24013P Series

1.0mm

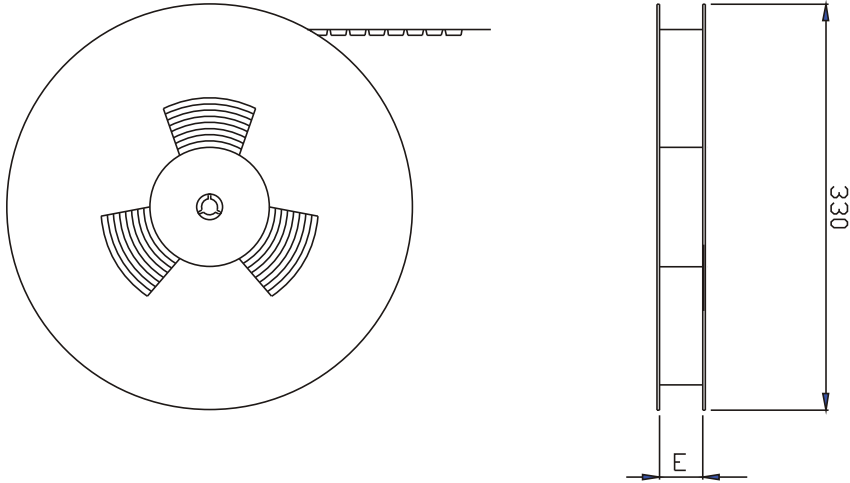
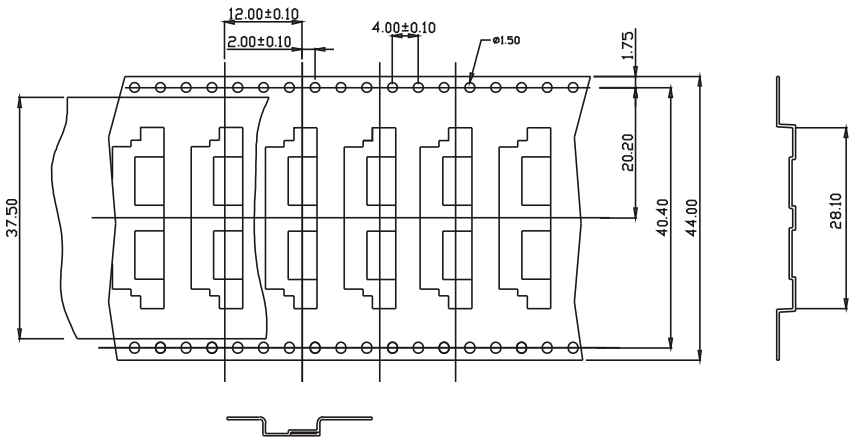

Unit: mm

POS.	E
14	44.40
20	44.40
30	56.40

24013 Wire to Board Connectors

HOUSING

Part No.: **P24013P20**

產品編號

Material: NYLON 94V-0

材質

Suitable Contact: 24013PS-00

配合端子

Suitable Connector: MSB24013P20

配合公座

Applicable Wire: AWG# 28~32

適用電線

Packing: 1,000pcs(Polybag)

包裝數量

PERFORMANCE

Electrical Rating: AC/DC 100V 0.3A

額定電壓電流

Insulation Resistance: 500MΩ min.

絕緣阻抗

Withstanding Voltage: 300V AC/minute

耐電壓

Temperature Range: -35°C~+85°C

適用溫度



1.0mm

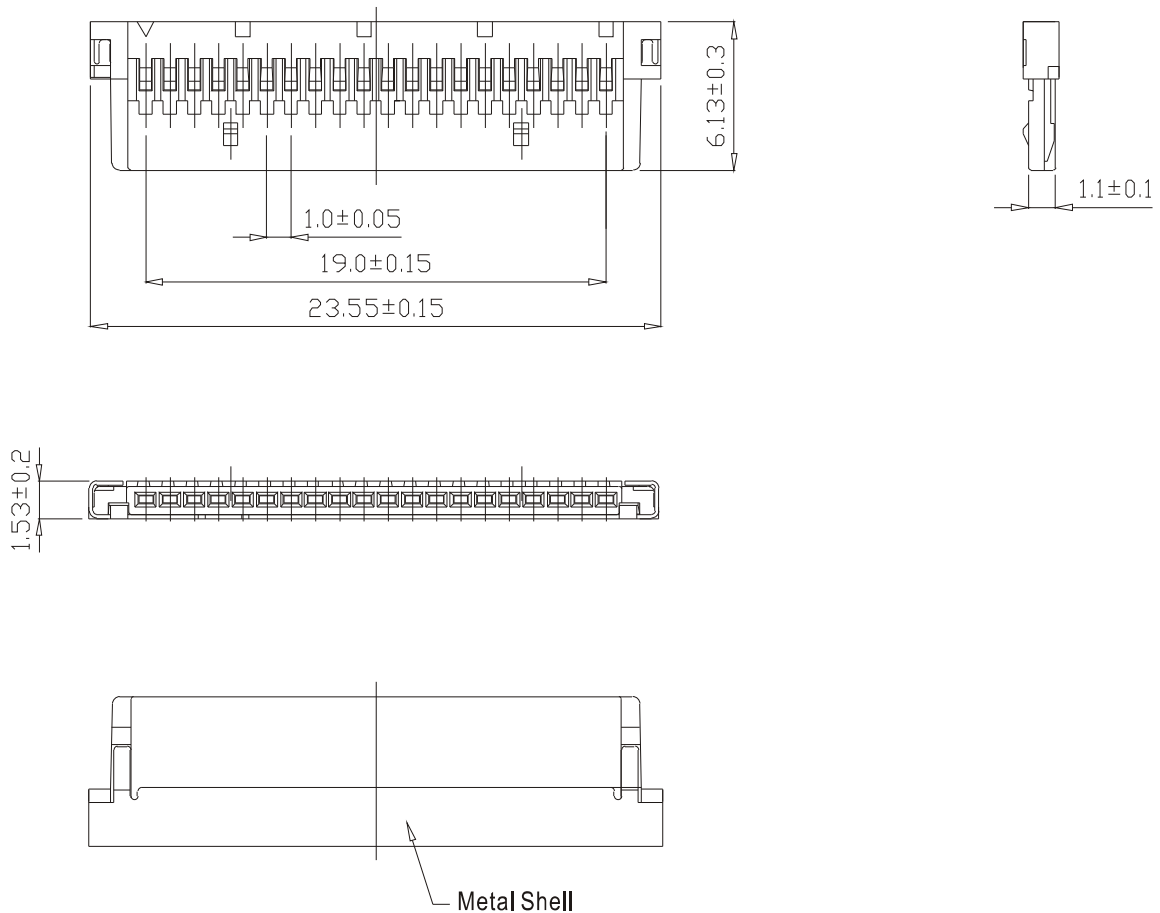

24013 Wire to Board Connectors

TERMINAL

Part No.: 24013PS-00

產品編號

Thickness: 0.15mm

銅板厚度

Material: Phosphor Bronze

材質 磷青銅

Surface Treatment: Gold-plated

表面處理 鍍金

Applicable Wire: AWG# 30~32

適用電線

Suitable Housing: P24013P20

配合塑膠

Suitable Connector: MSB24013P20

配合公座

MSB24013P20 RF:A

MSB24013P20 RF:HA

Packing: 10,000PCS(Reel)

包裝數量

PERFORMANCE

Electrical Rating: AC/DC 100V 0.3A

額定電壓電流

Insulation Resistance: 500MΩ min.

絕緣阻抗

Withstanding Voltage: 300V AC/minute

耐電壓

Temperature Range: -35°C~+85°C

適用溫度



1.0mm

