

24022-MSK

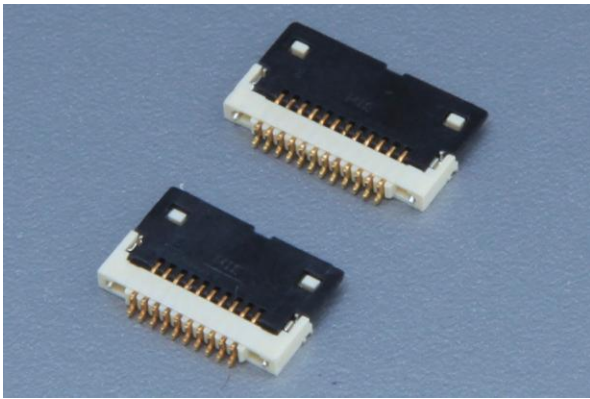

Pitch **0.5mm** FPC Connectors - SMT Type



PERFORMANCE

Electrical Rating: AC/DC 50V 0.5A

額定電壓電流

Insulation Resistance: 500MΩ min.

絕緣阻抗

Withstanding Voltage: 150V AC/minute

耐電壓

Temperature Range: -55°C~+85°C

適用溫度



CONNECTOR

Part No.: MSK24022P8~ MSK24022P40

產品編號

Material: Housing: LCP 94V-0

材質 塑膠座

Contact Pin: P.B. Each 50% of gold&nickel plated

接觸針 磷青銅 鍍半金錫

Clamshell: NYLON 94V-0, Black

旋轉蓋 黑色

Reinforcement: P.B. Tin-plated

補強片 磷青銅 鍍錫

Applicable Wire: FPC t=0.20mm

適用電線

Packing: 4000PCS (REEL)

包裝數量

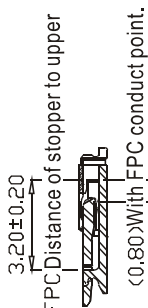
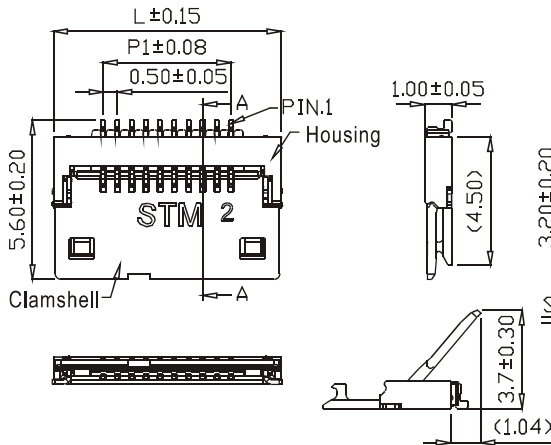
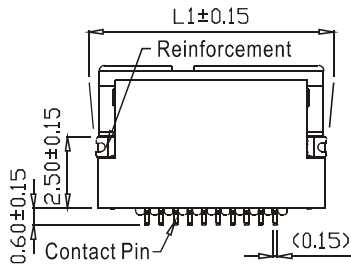
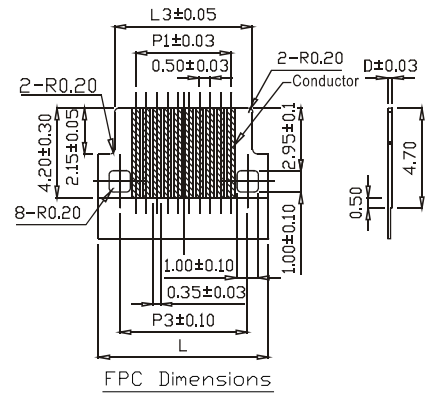
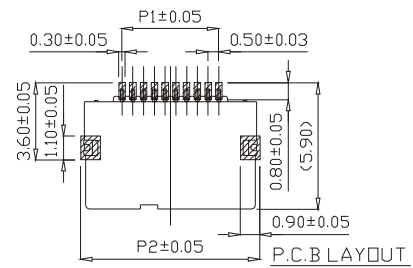

TOLERANCE	
.0	±0.25
.00	±0.15
.000	±0.05

Unit: mm

Part No.	POS	L	L1	L3	P1	P2	P3	D
MSK24022P8	8	7.00	7.08	5.50	3.50	7.32	5.02	0.20
MSK24022P10	10	8.00	8.08	6.50	4.50	8.32	6.02	0.20
MSK24022P12	12	9.00	9.08	7.50	5.50	9.32	7.02	0.20
MSK24022P40	40	23.00	23.20	21.50	19.50	23.32	21.02	0.20

Behave in conformity with continual product development policy, Sin Sheng (STM) reserves the right of specification changing of contents described in this catalogue at any time and without prior notice. Please contact the sales department nearby for most updated information.
由於產品持續開發的政策，信盛(STM)保留隨時變更本目錄所述之規格且不需提前通知的權利。請聯繫業務處查詢最新的產品資訊。

24022-LOCK FFC/FPC Connectors - SMT Type

Embossed Carrier Tape Dimensional Drawing

- MSK24022P8
- MSK24022P10
- MSK24022P12
- MSK24022P40



0.5mm

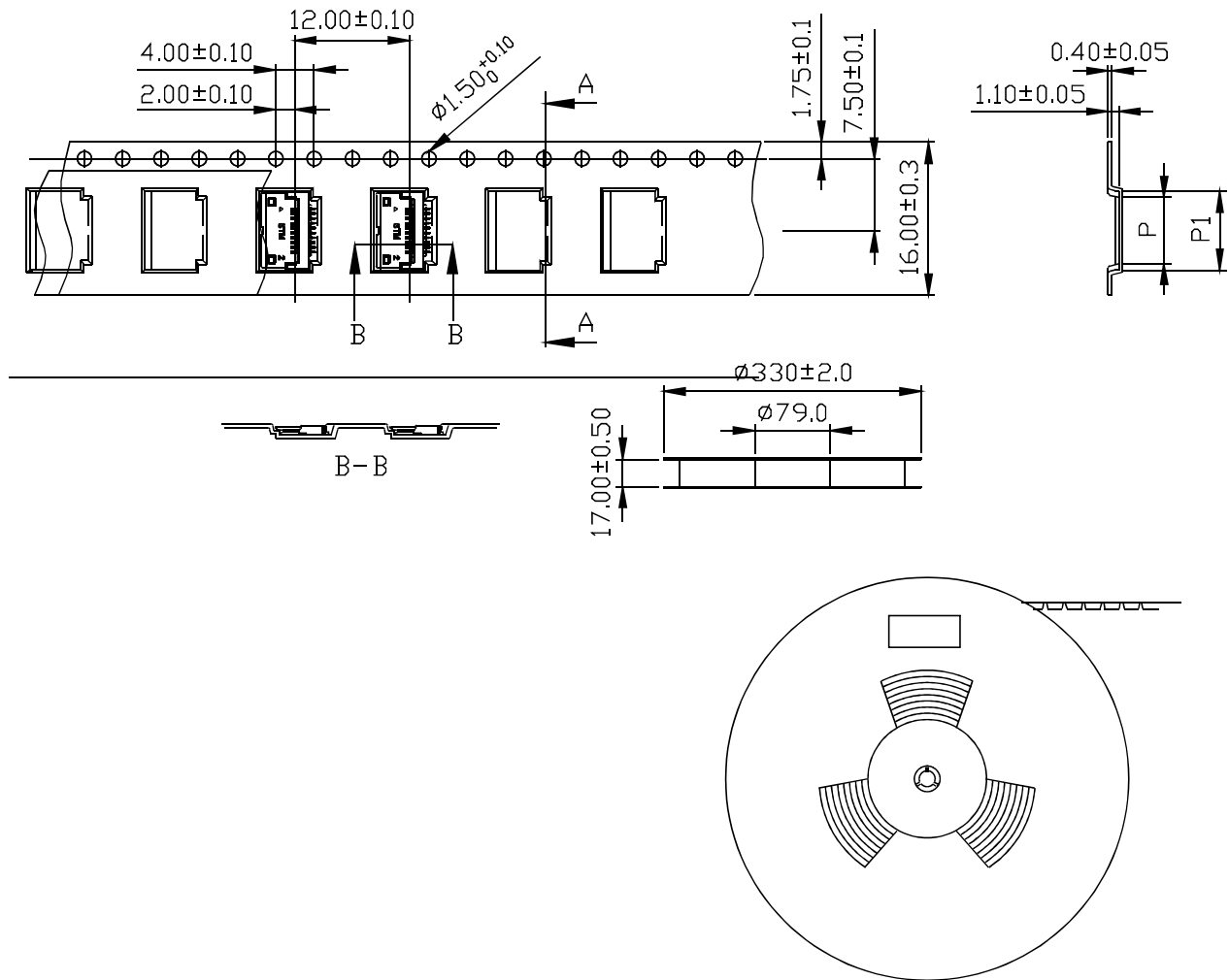

Onward direction of finished product
成品出料方向

Unit: mm

Part No.	POS	P	P1
MSK24020P8	8	$5.30 + 0.20$ $- 0$	7.30 ± 0.05
MSK24020P10	10	$6.30 + 0.20$ $- 0$	8.30 ± 0.05
MSK24020P12	12	$7.30 + 0.05$ $- 0.10$	$9.25 + 0.06$ $- 0.05$
MSK24020P40	40	$21.30 + 0.05$ $- 0.10$	$23.3 + 0.06$ $- 0.05$