

24022

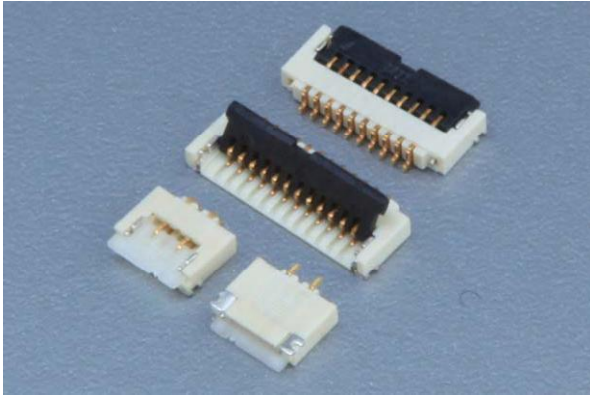

Pitch **0.5mm** FPC Connectors - SMT Type



PERFORMANCE

Electrical Rating: AC/DC 50V 0.5A

額定電壓電流

Insulation Resistance: 500MΩ min.

絕緣阻抗

Withstanding Voltage: 150V AC/minute

耐電壓

Temperature Range: -55°C~+85°C

適用溫度



0.5mm

CONNECTOR - Downward Contact

Part No.: **MS24022P12**

產品編號

Material: Housing: LCP 94V-0

材質 塑膠座

Clamshell: Nylon 94V-0, Black

旋轉蓋 黑色

Contact Pin: P.B

接觸針 磷青銅

Reinforcement: PB

補強片 磷青銅

Applicable Wire: FPC: 0.3mm thick flat cable.

適用電線

Packing: 5,000PCS (Reel)

包裝數量

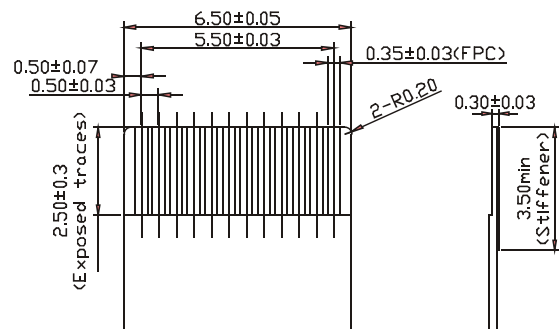
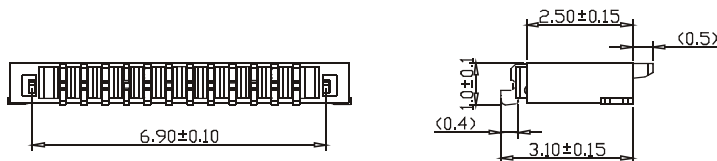
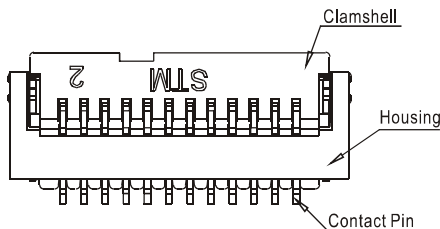
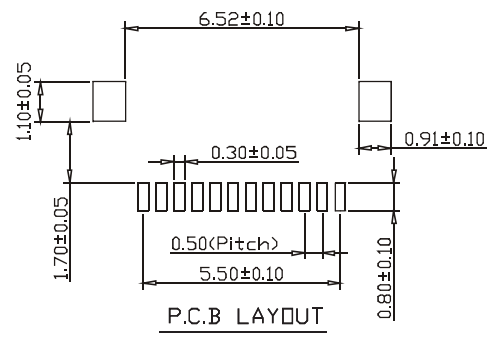

FPC Dimensions

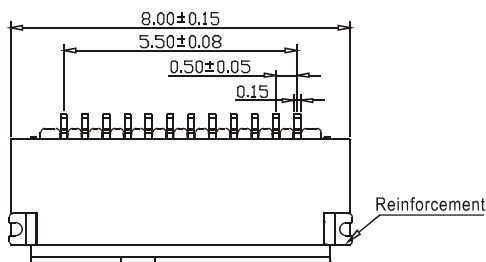

TOLERANCE	
.0	±0.25
.00	±0.15
.000	±0.05

Behave in conformity with continual product development policy, Sin Sheng (STM) reserves the right of specification changing of contents described in this catalogue at any time and without prior notice. Please contact the sales department nearby for most updated information.
由於產品持續開發的政策, 倍盛(STM)保留隨時變更本目錄所述之規格且不需提前通知的權利, 請逕繫業務處查詢最新的產品資訊。

24022 FFC/FPC Connectors - SMT Type

CONNECTOR - Downward Contact

Part No.: MS24022P10 RF:B MS24022P12 RF:B

產品編號

Material: Housing: LCP 94V-0

材質 塑膠座

Clamshell: Nylon 94V-0, Black
旋轉蓋 黑色

Contact Pin: PB
接觸針 磷青銅

Reinforcement: PB
補強片 磷青銅

Applicable Wire: FPC 0.2mm thick.

適用電線

Packing: 5,000PCS (Reel)

包裝數量

PERFORMANCE

Electrical Rating: AC/DC 50V 0.5A

額定電壓電流

Insulation Resistance: 500MΩ min.

絕緣阻抗

Withstanding Voltage: 150V AC/minute

耐電壓

Temperature Range: -55°C ~ +85°C

適用溫度

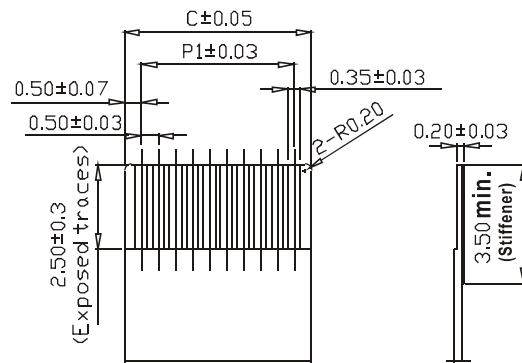
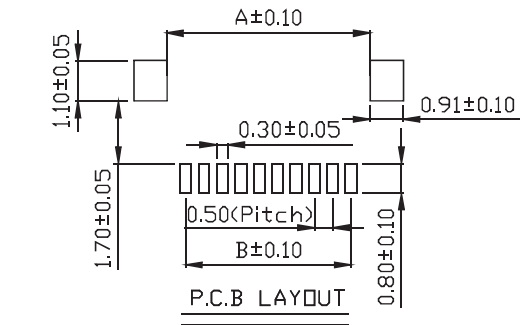
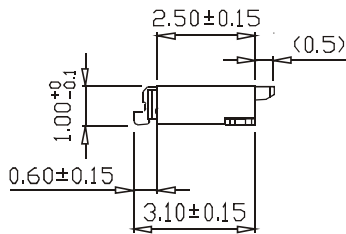
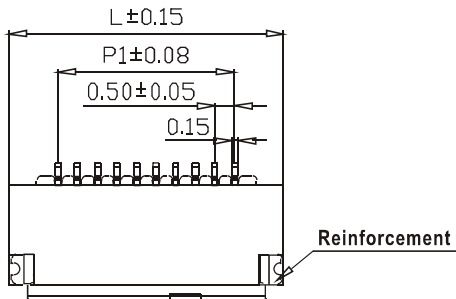
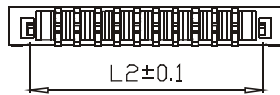
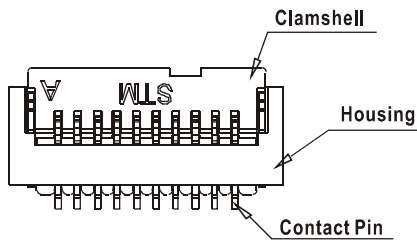

FPC Dimensions

Unit: mm

Part No.	RF	POS	L	L2	P1	A	B	C
MS24022P10	B	10	7.00	5.90	4.50	5.52	4.50	5.50
MS24022P12	B	12	8.00	6.90	5.50	6.52	5.50	6.50

TOLERANCE	
.0	±0.25
.00	±0.15
.000	±0.05

24022 FFC/FPC Connectors - SMT Type

Embossed Carrier Tape Dimensional Drawing

MS24022P10 RF:B
 MS24022P12
 MS24022P12 RF:B



0.5mm

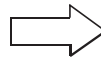
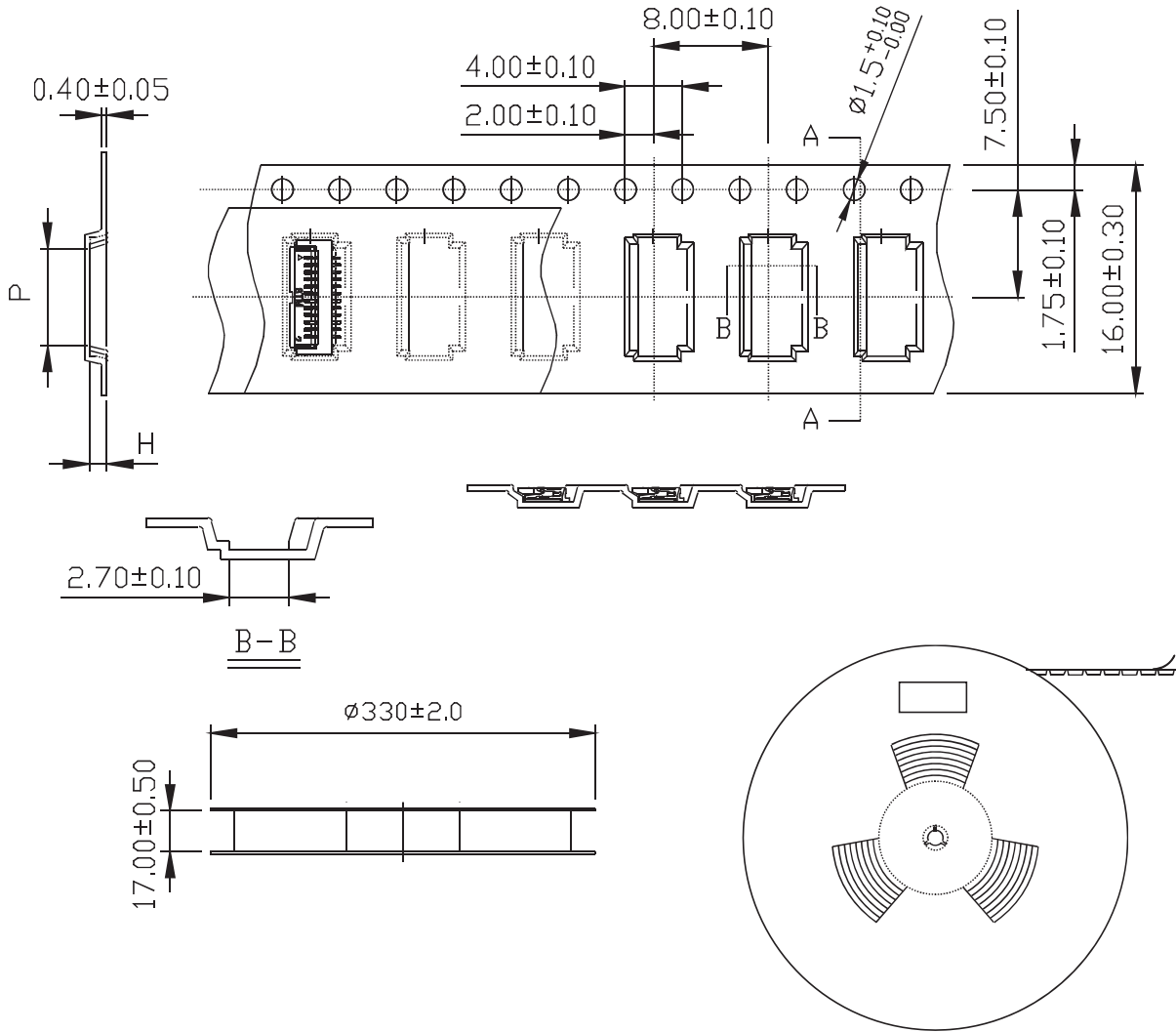

Onward direction of finished product
 成品出料方向

Unit: mm

Part No.	POS	P	H
MS24020P10	10	$5.80^{+0.20}_{-0.00}$	1.20 ± 0.05
MS24020P12	12	$6.80^{+0.20}_{-0.00}$	$1.20^{+0.10}_{-0.00}$