

2403

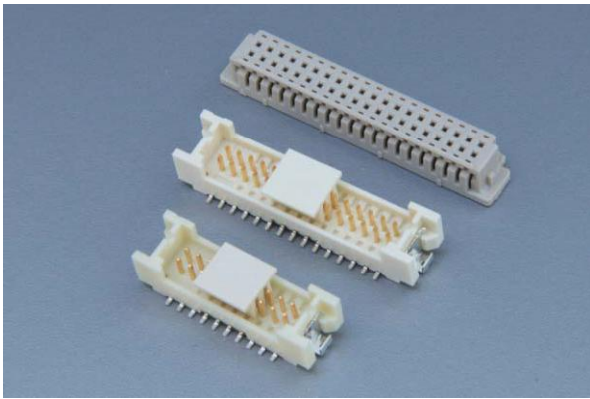

Pitch 1.25mm Wire to Board Connectors - SMT TYPE



PERFORMANCE

Electrical Rating: AC/DC 150V 1A
 額定電壓電流
 Insulation Resistance: 500MΩ min.
 絕緣阻抗
 Withstanding Voltage: 500V AC/minute
 耐電壓
 Temperature Range: -35°C~+85°C
 適用溫度



1.25mm

CONNECTOR - Top Entry

Part No.: MDS24035~MDS240320 RF:H

產品編號

Material: Housing: Nylon 94V-0

材質 塑膠座

Suitable Contact: 2403PS-2 2403PS-00

配合端子

Suitable Housing: PD24035~PD240320

配合塑膠

Applicable Wire: AWG# 26~30

適用電線

Square Contact Pin: 0.35±0.03mm

方型接觸針

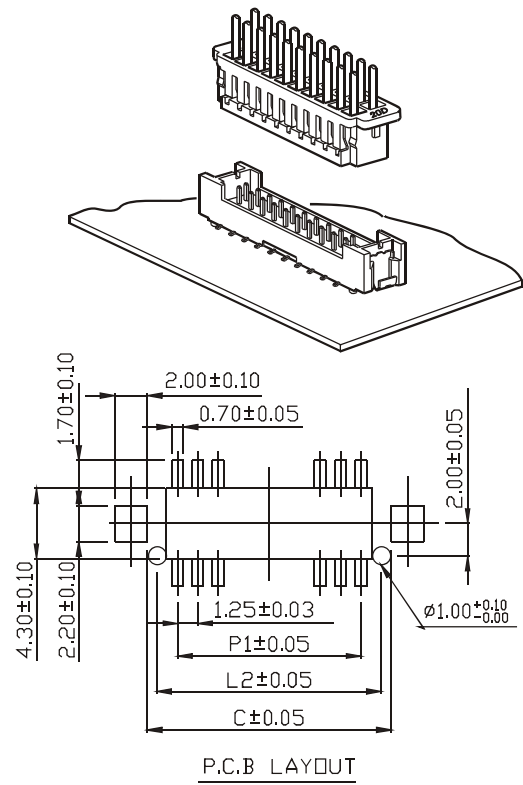
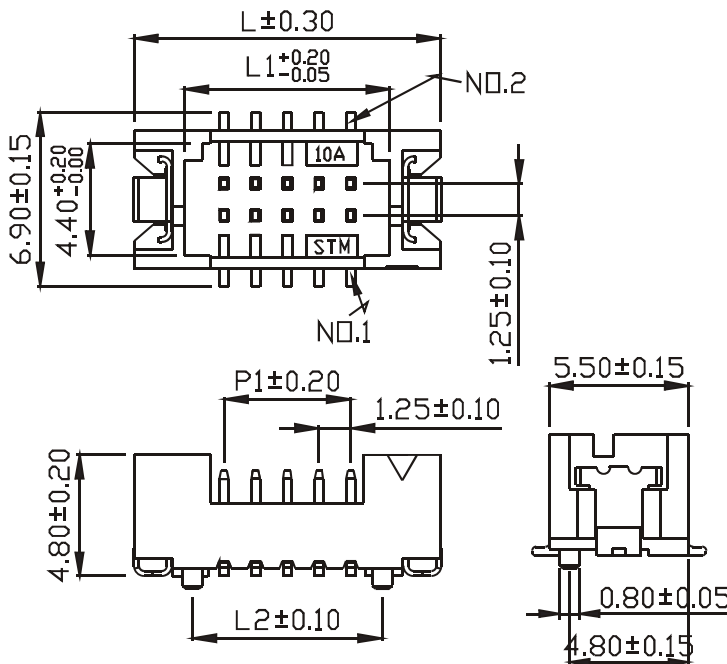

Special designs:

Part No. + RF	Packing and Surface Treatment 包裝方式和表面處理
P/NO+H	Reel packed+Suction+Gold-plated pins 捲裝 吸盤 接觸針鍍金
P/NO+HA	Reel pack+Suction+Tin-plated pins 捲裝 吸盤 接觸針鍍錫
P/NO+HB	Tube pack+Gold-plated pins 管裝 接觸針鍍金
P/NO+HC	Tube pack+Tin-plated pins 管裝 接觸針鍍錫
P/NO+HD	Tube pack+Suction+Gold-plated pins 管裝 吸盤 接觸針鍍金
P/NO+HE	Tube pack+Suction+Tin-plated pins 管裝 吸盤 接觸針鍍錫

Unit: mm

Part No.	POS.	L	L1	L2	P1	C	Reel	Tube
MDS24035	2X5	12.10	8.10	7.50	5.00	8.70	1000	40
MDS240310	2X10	18.35	14.35	13.75	11.25	14.95	1000	26
MDS240315	2X15	24.60	20.60	20.00	17.50	21.20	1000	19
MDS240320	2X20	30.85	26.85	26.25	23.75	27.45	1000	15

Note: Embossed tape package provides with suction area.

Sample: MDS240320 RF:HA

Behave in conformity with continual product development policy, Sin Sheng (STM) reserves the right of specification changing of contents described in this catalogue at any time and without prior notice. Please contact the sales department nearby for most updated information.
 由於產品持續開發的政策, 信盛(STM)保留隨時變更本目錄所述之規格且不需提前通知的權利, 請連繫業務處查詢最新的產品資訊。

2403 Wire to Board Connectors - SMT Type

CONNECTOR - Top Entry

Part No.: MDS24035~MDS240320

產品編號

Material: Housing: Nylon 94V-0

材質 塑膠座

Contact Pin: Brass, Gold-flash

接觸針 黃銅, 鍍金

Reinforcement: Phos.

補強片 磷青銅

Suitable Contact: 2403PS-2 2403PS-00

配合端子

Suitable Housing: PD24035~PD240320

配合塑膠

Applicable Wire: AWG# 26~30

適用電線

Square Contact Pin: $0.35 \pm 0.03\text{mm}$

方型接觸針

PERFORMANCE

Electrical Rating: AC/DC 150V 1A

額定電壓電流

Insulation Resistance: $500\text{M}\Omega$ min.

絕緣阻抗

Withstanding Voltage: 500V AC/minute

耐電壓

Temperature Range: $-35^{\circ}\text{C} \sim +85^{\circ}\text{C}$

適用溫度

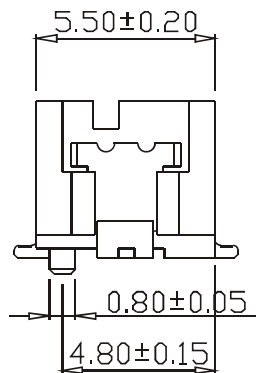
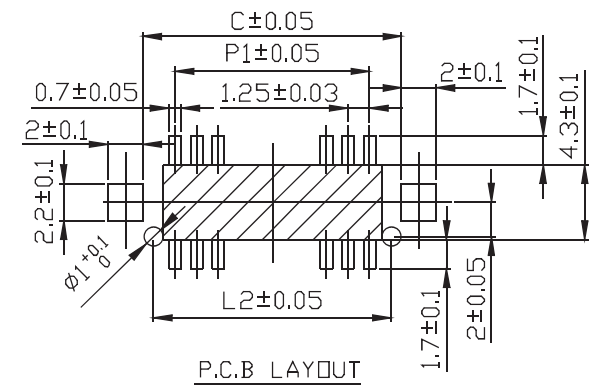
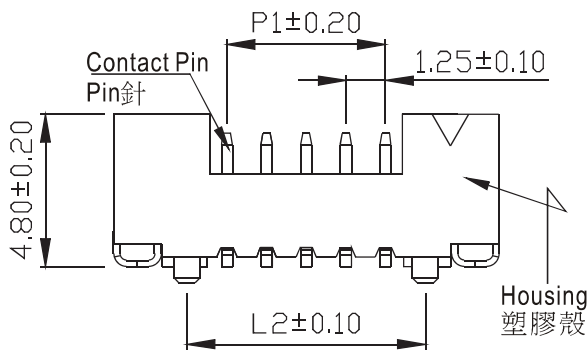
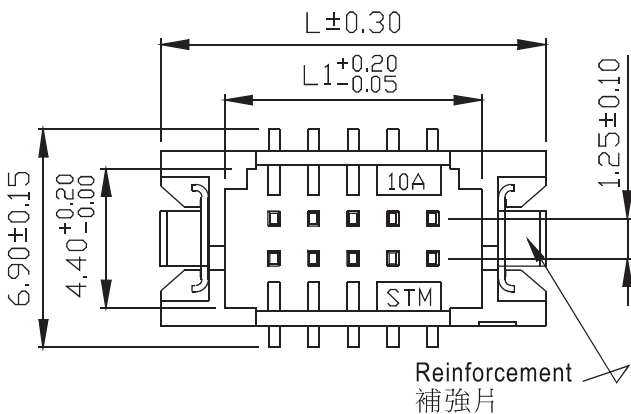

Unit: mm

Part No.	POS.	L	L1	L2	P1	C	Reel	Tube
MDS24035	2X5	12.10	8.10	7.50	5.00	8.70	1000	40
MDS240310	2X10	18.35	14.35	13.75	11.25	14.95	1000	26
MDS240315	2X15	24.60	20.60	20.00	17.50	21.20	1000	19
MDS240320	2X20	30.85	26.85	26.25	23.75	27.45	1000	15

Note: Embossed tape package provides with suction area.

1.25mm

2403 Wire to Board Connectors - SMT Type

CONNECTOR - Top Entry

Part No.: MDS24035~MDS240320 RF:F

產品編號

Material: Housing: Nylon 94V-0

材質 塑膠座

Contact Pin: Brass, half tin-plated/gold-plated

接觸針 黃銅, 鍍半金錫

Reinforcement: Phos.

補強片 磷青銅

Suitable Contact: 2403PS-2 2403PS-00

配合端子

Suitable Housing: PD24035~PD240320

配合塑膠

Applicable Wire: AWG# 26~30

適用電線

Square Contact Pin: $0.35 \pm 0.03\text{mm}$

方型接觸針

PERFORMANCE

Electrical Rating: AC/DC 150V 1A

額定電壓電流

Insulation Resistance: $500\text{M}\Omega$ min.

絕緣阻抗

Withstanding Voltage: 500V AC/minute

耐電壓

Temperature Range: $-35^{\circ}\text{C} \sim +85^{\circ}\text{C}$

適用溫度



1.25mm

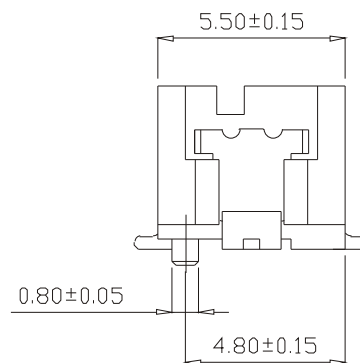
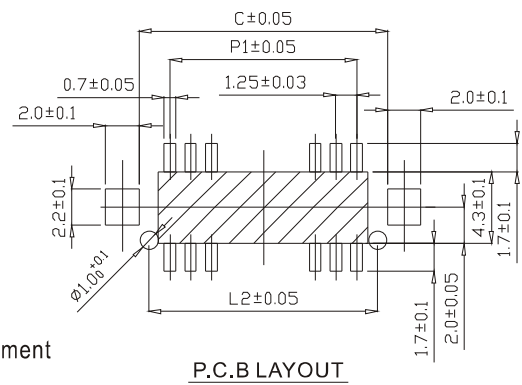
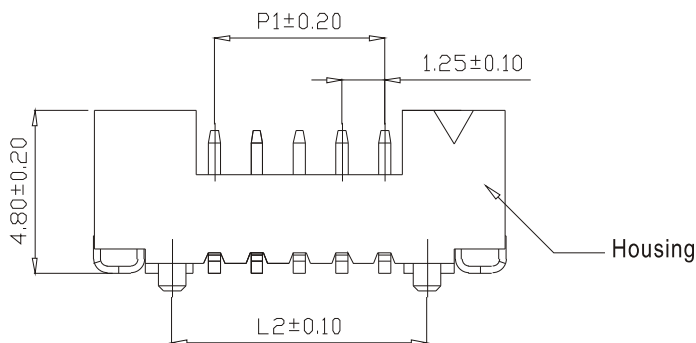
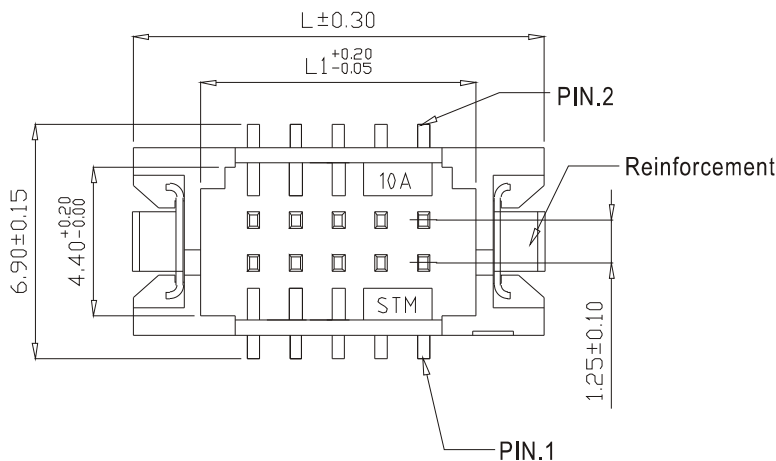

Unit: mm

Part No.	RF	POS.	L	L1	L2	P1	C
MDS24035	F	2X5	12.10	8.10	7.50	5.00	8.70
MDS240310	F	2X10	18.35	14.35	13.75	11.25	14.95
MDS240315	F	2X15	24.60	20.60	20.00	17.50	21.20
MDS240320	F	2X20	30.85	26.85	26.25	23.75	27.45

Packing: 1000pcs/Reel

2403 Wire to Board Connectors - SMT Type



Embossed Carrier Tape Dimensional Drawing

MDS2403Series

1.25mm

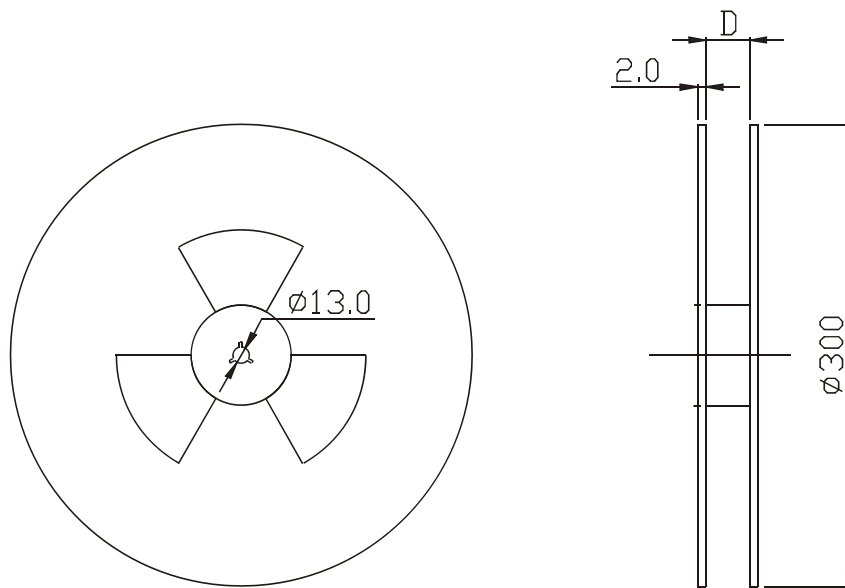
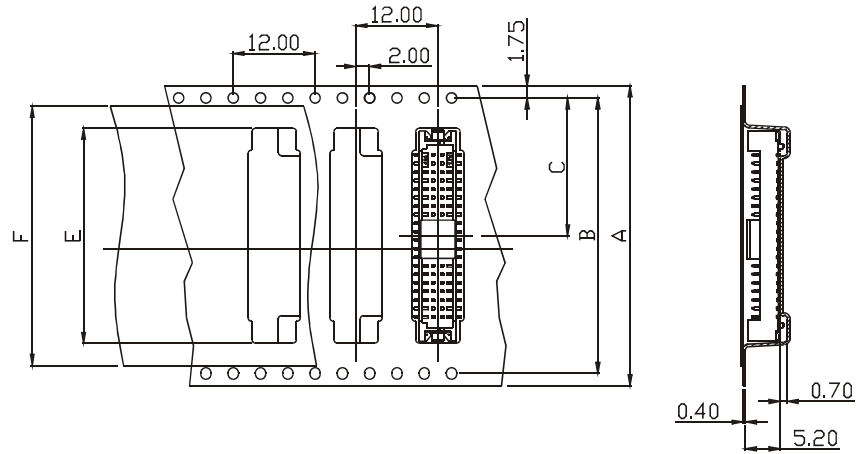

Unit: mm

POS.	A	B	C	D	E	F
2X5	24		11.50	24.40	12.20	21.50
2X10	32	28.40	14.20	32.40	18.40	25.50
2X15	44	40.40	20.20	44.40	24.70	37.00
2X20	44	40.40	20.20	44.40	30.95	37.00

2403 Wire to Board Connectors - SMT Type

CONNECTOR - Tope Entry

Part No.: MS24032~MS240315

產品編號

Material: Housing: Nylon 94V-0

材質 塑膠座

Contact Pin: Brass, Gold-flash

接觸針 黃銅, 鍍金

Suitable Contact: 2403PS-2 2403PS-00

配合端子

Suitable Housing: P24032~P240315

配合塑膠

Applicable Wire: AWG# 26~30

適用電線

Square Contact Pin: 0.35±0.02mm

方型接觸針

PERFORMANCE

Electrical Rating: AC/DC 100V 1A

額定電壓電流

Insulation Resistance: 500MΩ min.

絕緣阻抗

Withstanding Voltage: 500V AC/minute

耐電壓

Temperature Range: -25°C~+85°C

適用溫度



1.25mm

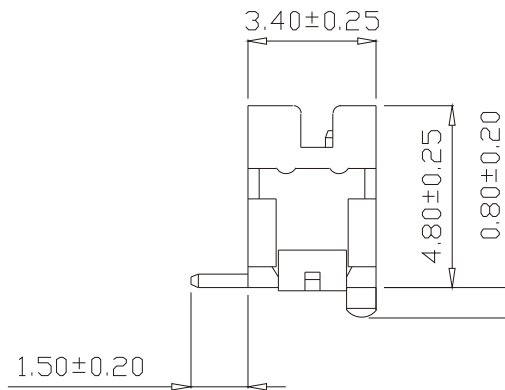
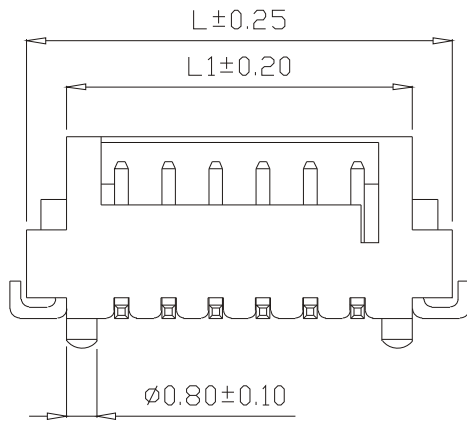
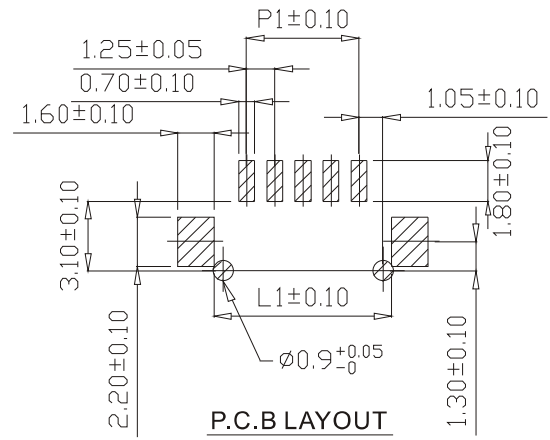
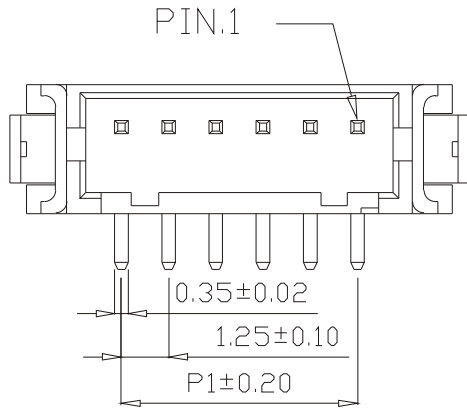

Unit: mm

PartNo.	POS.	L	L1	P1	Pack.	PartNo.	POS.	L	L1	P1	Pack.
MS24032	2	6.25	4.15	1.25	1000	MS24039	9	15.00	12.90	10.00	1000
MS24033	3	7.50	5.40	2.50	1000	MS240310	10	16.25	14.15	11.25	1000
MS24034	4	8.75	6.65	3.75	1000	MS240311	11	17.50	15.40	12.50	1000
MS24035	5	10.00	7.90	5.00	1000	MS240312	12	18.75	16.65	13.75	1000
MS24036	6	11.25	9.15	6.25	1000	MS240313	13	20.00	17.90	15.00	1000
MS24037	7	12.50	10.40	7.50	1000	MS240314	14	21.25	19.15	16.25	1000
MS24038	8	13.75	11.65	8.75	1000	MS240315	15	22.50	20.40	17.50	1000

2403 Wire to Board Connectors - SMT Type



CONNECTOR - Side Entry

Part No.: MS24032R~MS240315R

產品編號

Material: Housing: Nylon 94V-0

材質 塑膠座

Contact Pin: Brass, Gold-flash

接觸針 黃銅, 鍍金

Suitable Contact: 2403PS-2 2403PS-00

配合端子

Suitable Housing: P24032~P240315

配合塑膠

Applicable Wire: AWG# 26~30

適用電線

Square Contact Pin: 0.35±0.05mm

方型接觸針

PERFORMANCE

Electrical Rating: AC/DC 100V 1A
額定電壓電流

Insulation Resistance: 500MΩ min.
絕緣阻抗

Withstanding Voltage: 500V AC/minute
耐電壓

Temperature Range: -25°C~+85°C
適用溫度



1.25mm

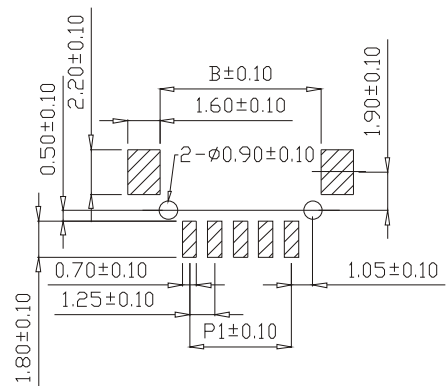
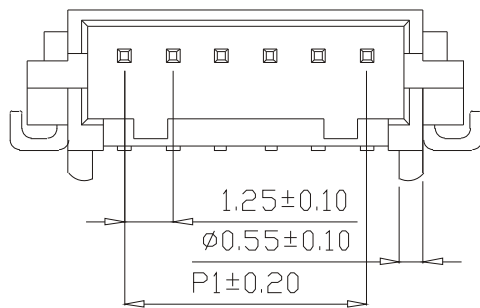

P.C.B LAYOUT

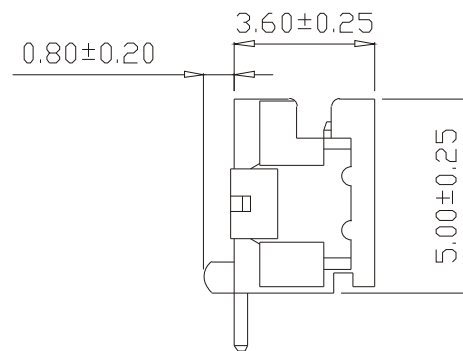
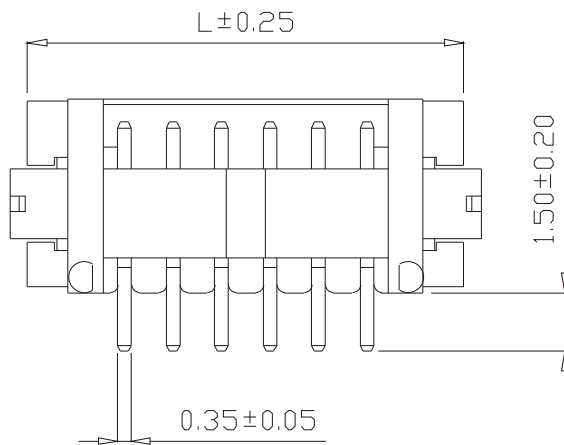

Unit: mm

PartNo.	POS.	L	B	P1	Pack.
MS24032R	2	6.25	4.15	1.25	1000
MS24033R	3	7.50	5.40	2.50	1000
MS24034R	4	8.75	6.65	3.75	1000
MS24035R	5	10.00	7.90	5.00	1000
MS24036R	6	11.25	9.15	6.25	1000
MS24037R	7	12.50	10.40	7.50	1000
MS24038R	8	13.75	11.65	8.75	1000

PartNo.	POS.	L	B	P1	Pack.
MS24039R	9	15.00	12.90	10.00	1000
MS240310R	10	16.25	14.15	11.25	1000
MS240311R	11	17.50	15.40	12.50	1000
MS240312R	12	18.75	16.65	13.75	1000
MS240313R	13	20.00	17.90	15.00	1000
MS240314R	14	21.25	19.15	16.25	1000
MS240315R	15	22.50	20.40	17.50	1000

2403 Wire to Board Connectors



CONNECTOR - Top Entry

Part No.: M24032~M240315

產品編號

Material: Housing: Nylon 94V-0

材質

塑膠座

Contact Pin: Brass, Gold-flash

接觸針

黃銅,

鍍金

Suitable Contact: 2403PS-2 2403PS-00

配合端子

Suitable Housing: P24032~P240315

配合塑膠

Applicable Wire: AWG# 26~30

適用電線

Square Contact Pin: $0.35 \pm 0.02\text{mm}$

方型接觸針

PERFORMANCE

Electrical Rating: AC/DC 150V 1A

額定電壓電流

Insulation Resistance: $500\text{M}\Omega$ min.

絕緣阻抗

Withstanding Voltage: 500V AC/minute

耐電壓

Temperature Range: $-35^{\circ}\text{C} \sim +85^{\circ}\text{C}$

適用溫度



1.25mm

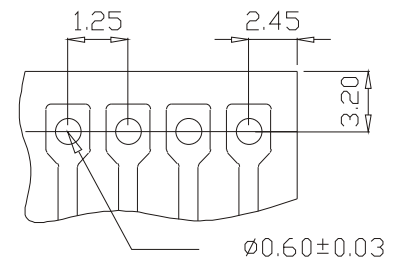
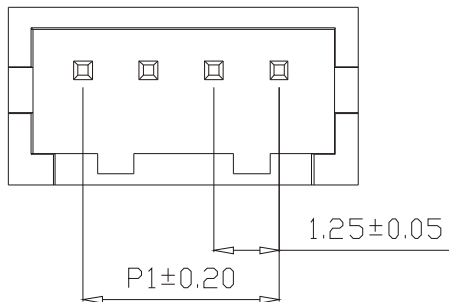

P.C.B LAYOUT

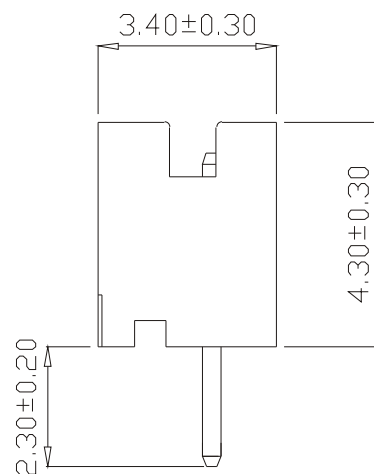
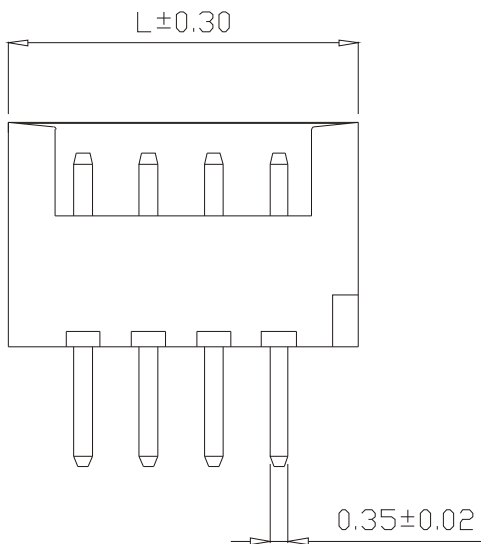

Unit: mm

PartNo.	POS.	L	P1	Pack.	PartNo.	POS.	L	P1	Pack.
M24032	2	4.15	1.25	500	M24039	9	12.90	10.00	500
M24033	3	5.40	2.50	500	M240310	10	14.15	11.25	500
M24034	4	6.65	3.75	500	M240311	11	15.40	12.50	500
M24035	5	7.90	5.00	500	M240312	12	16.65	13.75	500
M24036	6	9.15	6.25	500	M240313	13	17.90	15.00	500
M24037	7	10.40	7.50	500	M240314	14	19.15	16.25	500
M24038	8	11.65	8.75	500	M240315	15	20.40	17.50	500

2403 Wire to Board Connectors



CONNECTOR - Top Entry

Part No.: M24032R~M240315R

產品編號

Material: Housing: Nylon 94V-0

材質

Contact Pin: Brass, Gold-flash

接觸針 黃銅, 鍍金

Suitable Contact: 2403PS-2 2403PS-00

配合端子

Suitable Housing: P24032~P240315

配合塑膠

Applicable Wire: AWG# 26~30

適用電線

Square Contact Pin: $0.35 \pm 0.02\text{mm}$

方型接觸針

PERFORMANCE

Electrical Rating: AC/DC 150V 1A
額定電壓電流

Insulation Resistance: $500\text{M}\Omega$ min.
絕緣阻抗

Withstanding Voltage: 500V AC/minute
耐電壓

Temperature Range: $-25^{\circ}\text{C} \sim +85^{\circ}\text{C}$
適用溫度



1.25mm

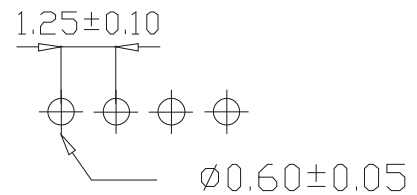
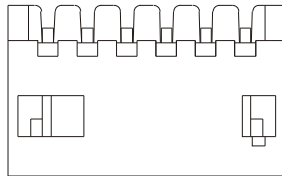

P.C.B LAYOUT

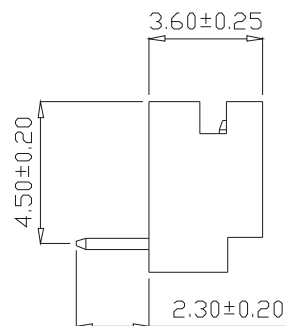
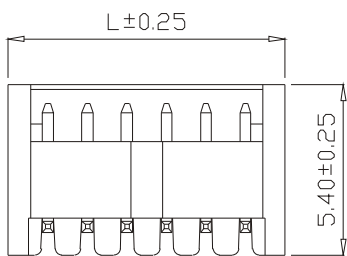
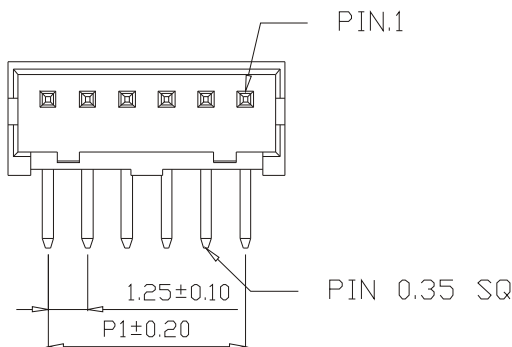

Unit: mm

PartNo.	POS.	L	P1	Pack.	PartNo.	POS.	L	P1	Pack.
M24032R	2	3.75	1.25	1000	M24039R	9	12.50	10.00	1000
M24033R	3	5.00	2.50	1000	M240310R	10	13.75	11.25	1000
M24034R	4	6.25	3.75	1000	M240311R	11	15.00	12.50	1000
M24035R	5	7.50	5.00	1000	M240312R	12	16.25	13.75	1000
M24036R	6	8.75	6.25	1000	M240313R	13	17.50	15.00	1000
M24037R	7	10.00	7.50	1000	M240314R	14	18.75	16.25	1000
M24038R	8	11.25	8.75	1000	M240315R	15	20.00	17.50	1000

2403 Wire to Board Connectors



HOUSING

Part No.: P24032~P240315

產品編號

Material: Nylon 94V-0

材質

Suitable Contact: 2403PS-2 2403PS-00

配合端子

Suitable Connector: M24032~M240315

配合公座

Applicable Wire: AWG# 26~30

適用電線

PERFORMANCE

Electrical Rating: AC/DC 150V 1A

額定電壓電流

Insulation Resistance: 500MΩ min.

絕緣阻抗

Withstanding Voltage: 500V AC/minute

耐電壓

Temperature Range: -35°C~+85°C

適用溫度



1.25mm

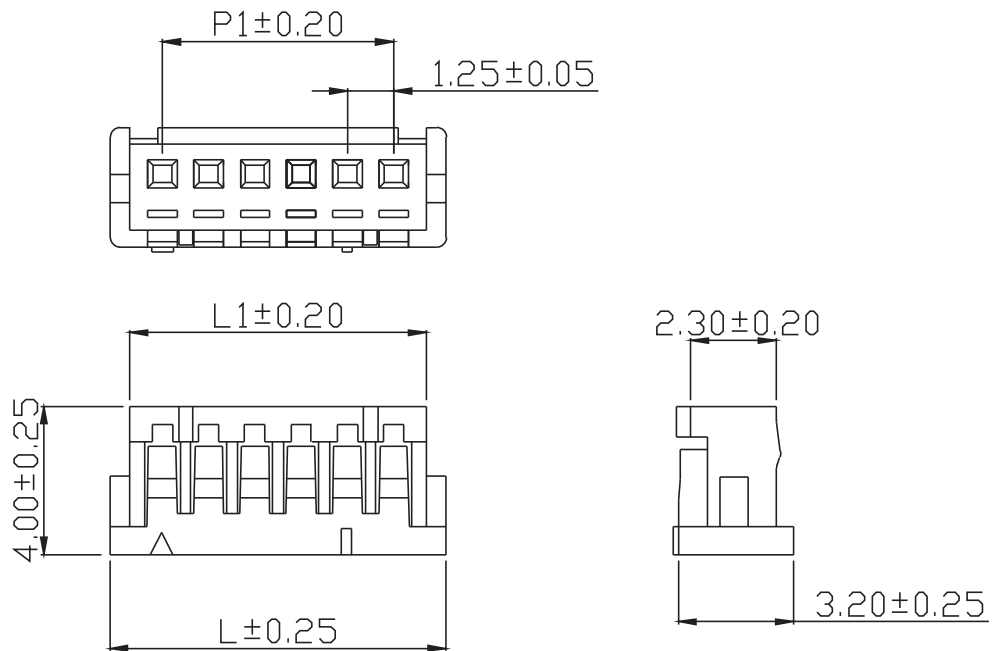

Unit: mm

Part No.	POS.	L	L1	P1	Pack.	Part No.	POS.	L	L1	P1	Pack.
P24032	2	4.15	3.05	1.25	1000	P24039	9	12.90	11.80	10.00	1000
P24033	3	5.40	4.30	2.50	1000	P240310	10	14.15	13.05	11.25	1000
P24034	4	6.65	5.55	3.75	1000	P240311	11	15.40	14.30	12.50	1000
P24035	5	7.90	6.80	5.00	1000	P240312	12	16.65	15.55	13.75	1000
P24036	6	9.15	8.05	6.25	1000	P240313	13	17.90	16.80	15.00	1000
P24037	7	10.40	9.30	7.50	1000	P240314	14	19.15	18.05	16.25	1000
P24038	8	11.65	10.55	8.75	1000	P240315	15	20.40	19.30	17.50	1000

2403 Wire to Board Connectors

HOUSING - Double Rows

Part No.: PD24035~PD240320

產品編號

PD24035~PD240320 RF:H (HF)

Material: Nylon 94V-0

材質

Suitable Contact: 2403PS-2 2403PS-00

配合端子

Suitable Connector: MDS24035~MDS240320

配合公座

Applicable Wire: AWG# 26~30

適用電線

PERFORMANCE

Electrical Rating: AC/DC 150V 1A

額定電壓電流

Insulation Resistance: 500MΩ min.

絕緣阻抗

Withstanding Voltage: 500V AC/minute

耐電壓

Temperature Range: -25°C~+85°C

適用溫度



1.25mm

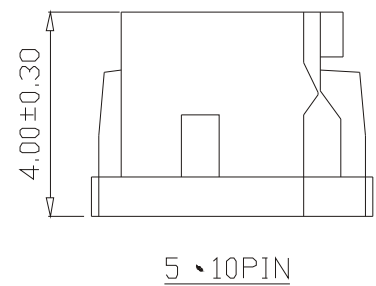
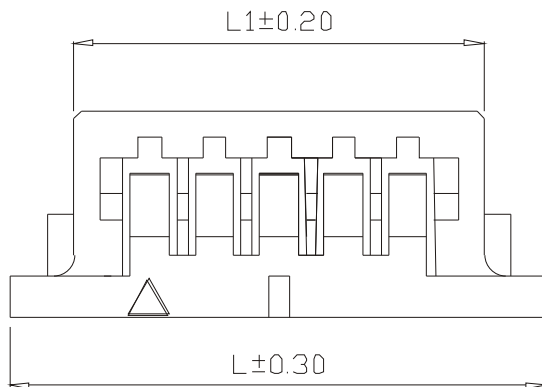
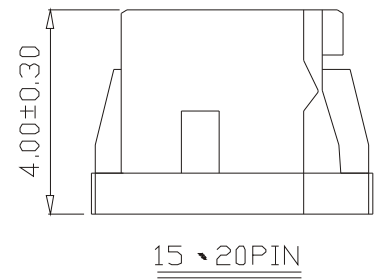
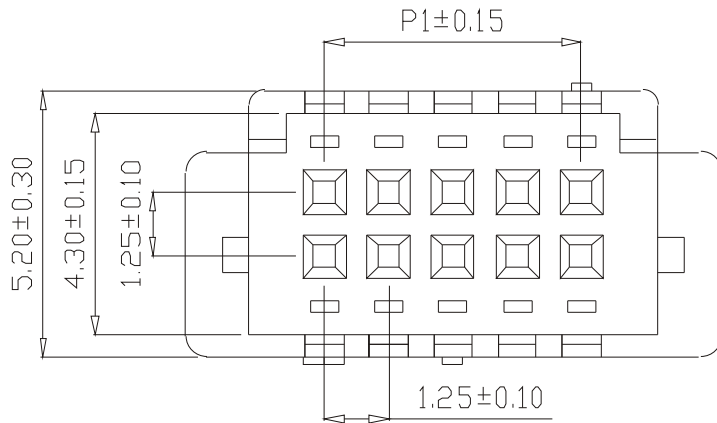

Unit: mm

Part No.	POS.	L	L1	P1	Pack.
PD24035	2X5	10.40	7.95	5.00	1000
PD240310	2X10	16.65	14.20	11.25	1000
PD240315	2X15	22.90	20.45	17.50	1000
PD240320	2X20	29.15	26.70	23.75	1000

Unit: mm

Part No.	RF	POS.	L	L1	P1	Pack.
PD24035	H	2X5	10.40	7.95	5.00	1000
PD240310	H	2X10	16.65	14.20	11.25	1000
PD240315	H	2X15	22.90	20.45	17.50	1000
PD240320	H	2X20	29.15	26.70	23.75	1000

2403 Wire to Board Connectors

TERMINAL

Part No.: 2403PS-2 2403PS-00

產品編號

Thickness: 0.15mm

銅板厚度

Material: Phosphor Bronze

材質 磷青銅

Surface Treatment: Tin-plated (-2)

表面處理

鍍錫

Gold-flash (-00)

鍍金

Applicable Wire: AWG# 26~30

適用電線

Insulation O.D.: 0.80~1.20mm

線皮外徑

Suitable Housing: P24032~P240315

配合塑膠

PD24035~PD240320

Suitable Connector: M24032~M240315

配合公座

MDS24035~MDS240320

Packing: 15,000PCS(Reel)

包裝數量

PERFORMANCE

Electrical Rating: AC/DC 150V 1A

額定電壓電流

Insulation Resistance: 500MΩ min.

絕緣阻抗

Withstanding Voltage: 500V AC/minute

耐電壓

Temperature Range: -25°C~+85°C

適用溫度



1.25mm

