

24215

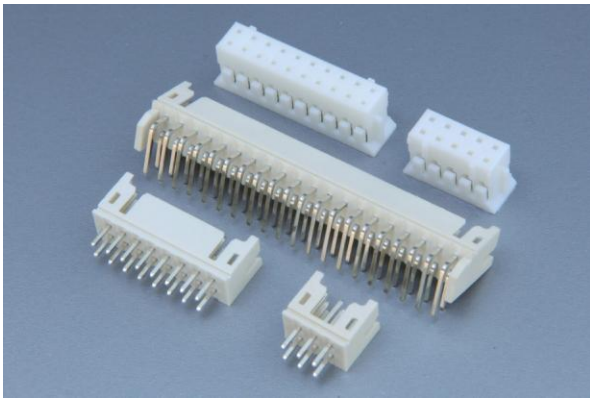

Pitch 2.0mm Wire to Board Connectors



PERFORMANCE

Electrical Rating: AC/DC 250V 1.5A
 額定電壓電流
 Insulation Resistance: 1000MΩ min.
 絕緣阻抗
 Withstanding Voltage: 800V AC/minute
 耐電壓
 Temperature Range: -25°C~+85°C
 適用溫度



CONNECTOR - Top Entry

Part No.: MD24215P2~MD24215P20

產品編號

Material: Housing: Nylon 94V-0

材質

塑膠座

Contact Pin: Brass, Tin-plated

接觸針

黃銅, 鍍錫

Suitable Contact: : 24215PS-2 24215PS-2 RF:A

配合端子

Suitable Connector: PD24215P2~PD24215P20

配合塑膠

Applicable Wire: AWG# 24~28

適用電線

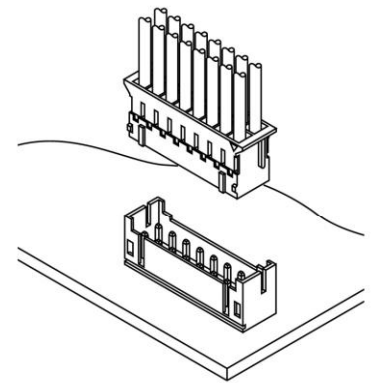

2.0mm

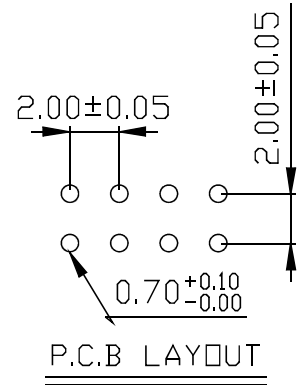
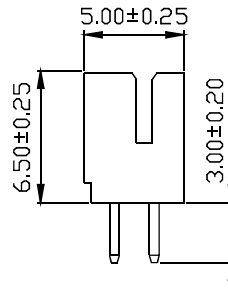
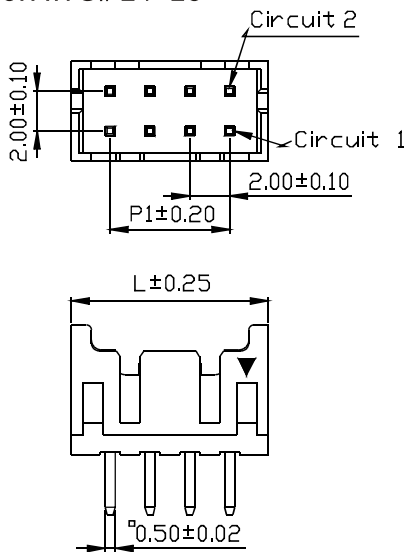

Unit: mm

PartNo.	POS.	L	P1	Pack.	PartNo.	POS.	L	P1	Pack.
MD24215P2	2X2	6.00	2.00	1000	MD24215P12	2X12	26.00	22.00	500
MD24215P3	2X3	8.00	4.00	1000	MD24215P13	2X13	28.00	24.00	500
MD24215P4	2X4	10.00	6.00	1000	MD24215P14	2X14	30.00	26.00	500
MD24215P5	2X5	12.00	8.00	1000	MD24215P15	2X15	32.00	28.00	500
MD24215P6	2X6	14.00	10.00	1000	MD24215P16	2X16	34.00	30.00	500
MD24215P7	2X7	16.00	12.00	1000	MD24215P17	2X17	36.00	32.00	500
MD24215P8	2X8	18.00	14.00	1000	MD24215P18	2X18	38.00	34.00	500
MD24215P9	2X9	20.00	16.00	1000	MD24215P19	2X19	40.00	36.00	500
MD24215P10	2X10	22.00	18.00	1000	MD24215P20	2X20	42.00	38.00	500
MD24215P11	2X11	24.00	20.00	500					

Behave in conformity with continual product development policy, Sin Sheng (STM) reserves the right of specification changing of contents described in this catalogue at any time and without prior notice. Please contact the sales department nearby for most updated information.
 由於產品持續開發的政策, 信盛(STM)保留隨時變更本目錄所述之規格且不需提前通知的權利, 請建繁業務處查詢最新的產品資訊。

24215 Wire to Board Connectors



CONNECTOR - Side Entry

Part No.: MD24215P2~MD24215P20 RF:A

產品編號

Material: Housing: Nylon 94V-0

材質

塑膠座

Contact Pin: Brass, Tin-plated

接觸針

黃銅, 鍍錫

Suitable Contact: : 24215PS

配合端子

Suitable Connector: PD24215P2~PD24215P20

配合塑膠

Applicable Wire: AWG# 24~28

適用電線

PERFORMANCE

Electrical Rating: AC/DC 250V 2A

額定電壓電流

Insulation Resistance: 1000MΩ min.

絕緣阻抗

Withstanding Voltage: 800V AC/minute

耐電壓

Temperature Range: -25°C~+85°C

適用溫度

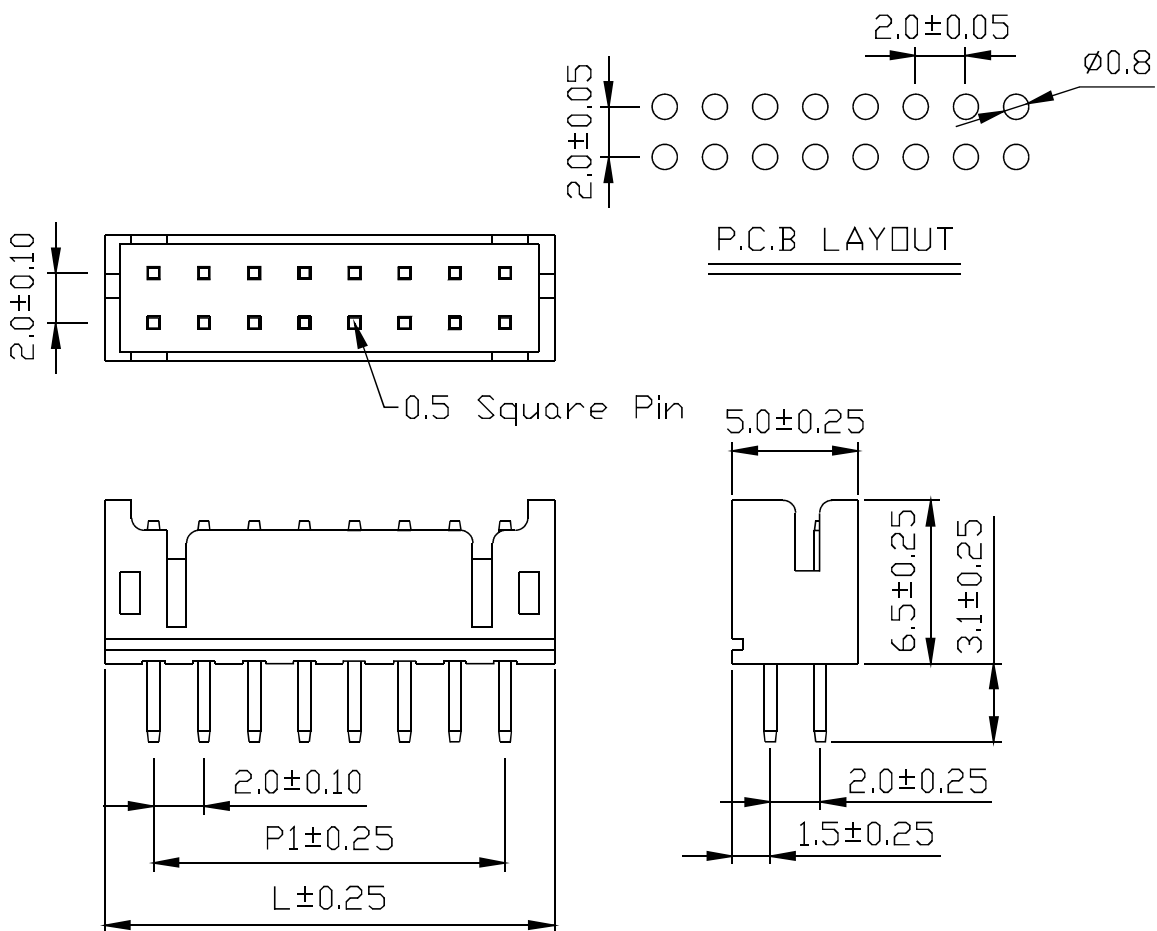

Note: Letters RF:A to be added follows the part number, i.e MD24215P2 RF:A.

Unit: mm

PartNo.	POS.	L	P1	Pack.	PartNo.	POS.	L	P1	Pack.
MD24215P2	2X2	6.00	2.00	1000	MD24215P11	2X11	24.00	20.00	500
MD24215P3	2X3	8.00	4.00	1000	MD24215P12	2X12	26.00	22.00	500
MD24215P4	2X4	10.00	6.00	1000	MD24215P13	2X13	28.00	24.00	500
MD24215P5	2X5	12.00	8.00	1000	MD24215P14	2X14	30.00	26.00	250
MD24215P6	2X6	14.00	10.00	500	MD24215P15	2X15	32.00	28.00	250
MD24215P7	2X7	16.00	12.00	500	MD24215P16	2X16	34.00	30.00	250
MD24215P8	2X8	18.00	14.00	500	MD24215P17	2X17	36.00	32.00	250
MD24215P9	2X9	20.00	16.00	500	MD24215P20	2X20	42.00	38.00	250
MD24215P10	2X10	22.00	18.00	500					

24215 Wire to Board Connectors

CONNECTOR - Side Entry

Part No.: MD24215P2R~MD24215P20R

產品編號

Material: Housing: Nylon 94V-0

材質

Contact Pin: Brass, Tin-plated

接觸針

黃銅, 鍍錫

Suitable Contact: : 24215PS-2 24215PS-2RF:A

配合端子

Suitable Connector: PD24215P2~PD24215P20

配合塑膠

Applicable Wire: AWG# 24~28

適用電線

PERFORMANCE

Electrical Rating: AC/DC 250V 1.5A

額定電壓電流

Insulation Resistance: 1000MΩ min.

絕緣阻抗

Withstanding Voltage: 800V AC/minute

耐電壓

Temperature Range: -25°C~+85°C

適用溫度

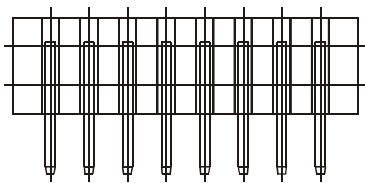
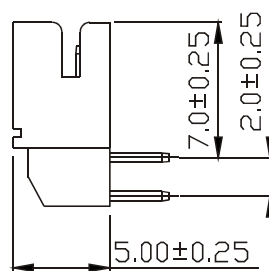
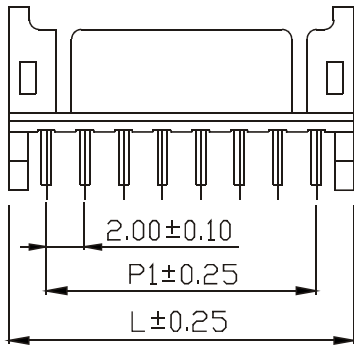
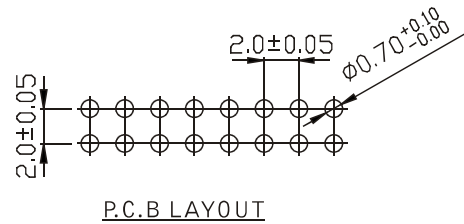
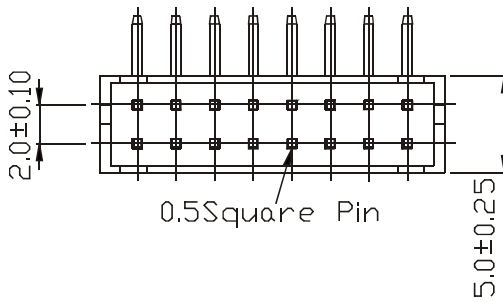

Unit: mm

PartNo.	POS.	L	P1	Pack.	PartNo.	POS.	L	P1	Pack.
MD24215P2R	2X2	6.00	2.00	1000	MD24215P12R	2X12	26.00	22.00	500
MD24215P3R	2X3	8.00	4.00	1000	MD24215P13R	2X13	28.00	24.00	500
MD24215P4R	2X4	10.00	6.00	1000	MD24215P14R	2X14	30.00	26.00	500
MD24215P5R	2X5	12.00	8.00	1000	MD24215P15R	2X15	32.00	28.00	500
MD24215P6R	2X6	14.00	10.00	1000	MD24215P16R	2X16	34.00	30.00	500
MD24215P7R	2X7	16.00	12.00	1000	MD24215P17R	2X17	36.00	32.00	500
MD24215P8R	2X8	18.00	14.00	1000	MD24215P18R	2X18	38.00	34.00	500
MD24215P9R	2X9	20.00	16.00	1000	MD24215P19R	2X19	40.00	36.00	500
MD24215P10R	2X10	22.00	18.00	1000	MD24215P20R	2X20	42.00	38.00	500
MD24215P11R	2X11	24.00	20.00	500					

24215 Wire to Board Connectors



CONNECTOR - Side Entry

Part No.: MD24215P2R~MD24215P17R RF:A

產品編號

Material: Housing: Nylon 94V-0

材質

塑膠座

Contact Pin: Brass, Tin-plated

接觸針

黃銅, 鍍錫

Suitable Contact: : 24215PS

配合端子

Suitable Connector: PD24215P2~PD24215P17

配合塑膠

Applicable Wire: AWG# 24~28

適用電線

PERFORMANCE

Electrical Rating: AC/DC 250V 2A

額定電壓電流

Insulation Resistance: 1000MΩ min.

絕緣阻抗

Withstanding Voltage: 800V AC/minute

耐電壓

Temperature Range: -25°C~+85°C

適用溫度

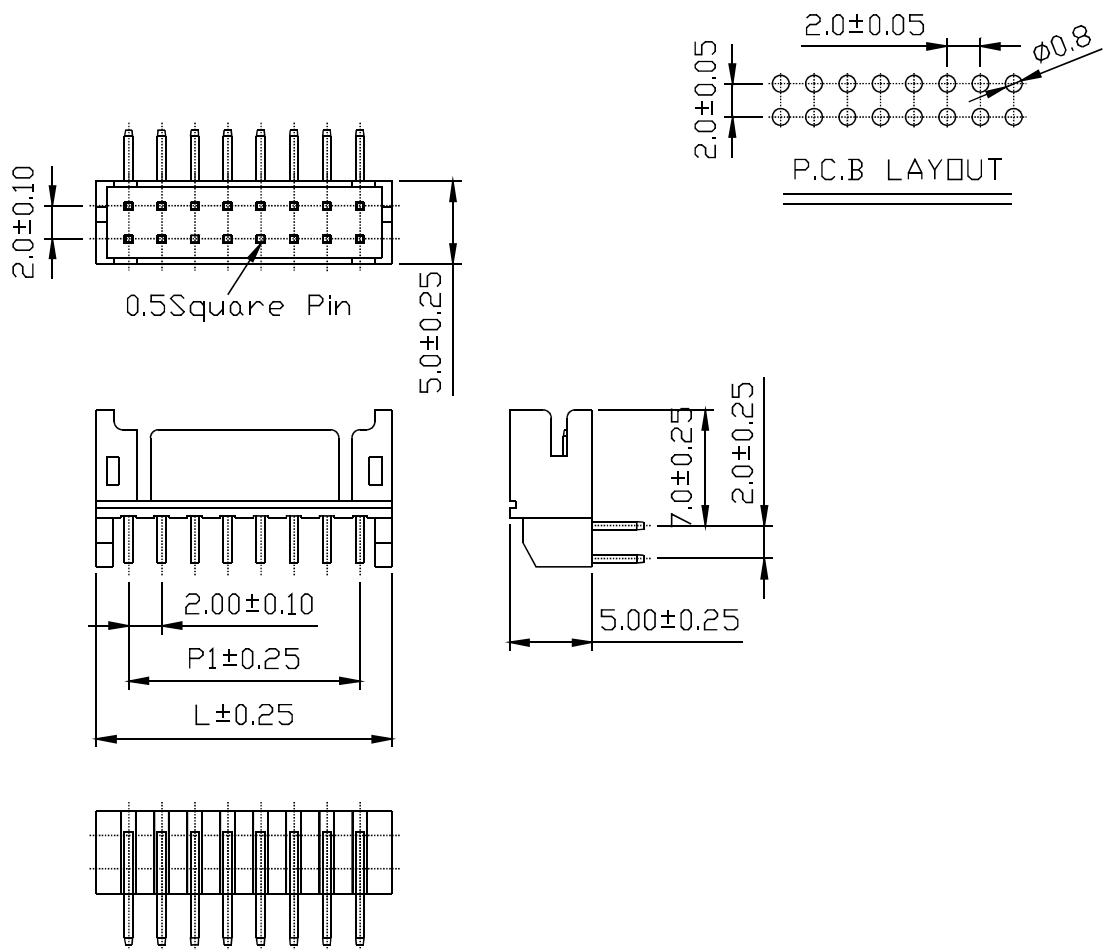

Note: Letters RF:A to be added follows the part number, i.e MD24215P2R RF:A.

Unit: mm

PartNo.	POS.	L	P1	Pack.	PartNo.	POS.	L	P1	Pack.
MD24215P2R	2X2	6.00	2.00	1000	MD24215P10R	2X10	22.00	18.00	1000
MD24215P3R	2X3	8.00	4.00	1000	MD24215P11R	2X11	24.00	20.00	500
MD24215P4R	2X4	10.00	6.00	1000	MD24215P12R	2X12	26.00	22.00	500
MD24215P5R	2X5	12.00	8.00	1000	MD24215P13R	2X13	28.00	24.00	500
MD24215P6R	2X6	14.00	10.00	1000	MD24215P14R	2X14	30.00	26.00	500
MD24215P7R	2X7	16.00	12.00	1000	MD24215P15R	2X15	32.00	28.00	500
MD24215P8R	2X8	18.00	14.00	1000	MD24215P16R	2X16	34.00	30.00	500
MD24215P9R	2X9	20.00	16.00	1000	MD24215P17R	2X17	36.00	32.00	500

24215 Wire to Board Connectors



HOUSING

Part No.: PD24215P2~PD24215P20

產品編號

Material: Nylon 94V-0

材質

Suitable Contact: : 24215PS-2

配合端子

Suitable Connector: MD24215P2~MD24215P20

配合公座

MD24215P2~MD24215P20 RF:A

MD24215P2R~MD24215P20R

MD24215P2R ~MD24215P17R RF:A

Applicable Wire: AWG# 24~28

適用電線

PERFORMANCE

Electrical Rating: AC/DC 250V 1.5A

額定電壓電流

Insulation Resistance: 1000MΩ min.

絕緣阻抗

Withstanding Voltage: 800V AC/minute

耐電壓

Temperature Range: -25°C~+85°C

適用溫度

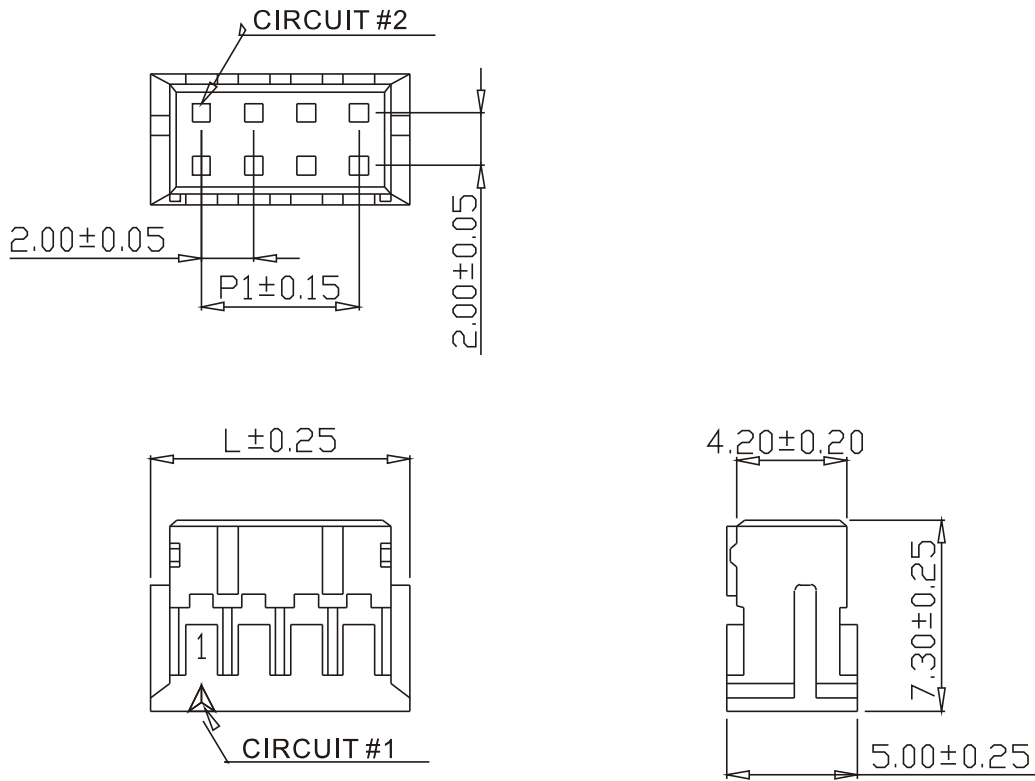

2.0mm

Unit: mm

PartNo.	POS.	L	P1	Pack.	PartNo.	POS.	L	P1	Pack.
PD24215P2	2X2	5.90	2.00	1000	PD24215P10	2X10	21.90	18.00	1000
PD24215P3	2X3	7.90	4.00	1000	PD24215P11	2X11	23.90	20.00	1000
PD24215P4	2X4	9.90	6.00	1000	PD24215P12	2X12	25.90	22.00	1000
PD24215P5	2X5	11.90	8.00	1000	PD24215P13	2X13	27.90	24.00	1000
PD24215P6	2X6	13.90	10.00	1000	PD24215P14	2X14	29.90	26.00	1000
PD24215P7	2X7	15.90	12.00	1000	PD24215P15	2X15	31.90	28.00	1000
PD24215P8	2X8	17.90	14.00	1000	PD24215P16	2X16	33.90	30.00	1000
PD24215P9	2X9	19.90	16.00	1000	PD24215P17	2X17	35.90	32.00	1000
PD24215P10	2X10	21.90	18.00	1000	PD24215P18	2X18	37.90	34.00	1000
PD24215P11	2X11	23.90	20.00	1000	PD24215P19	2X19	39.90	36.00	1000
PD24215P12	2X12	25.90	22.00	1000	PD24215P20	2X20	41.90	38.00	1000

24215 Wire to Board Connectors

TERMINAL

Part No.: 24215PS-2

產品編號

24215PS-2 RF:B

Thickness: 0.20mm

銅板厚度

Material: Phosphor Bronze

材質

磷青銅

Surface Treatment: Tin-plated

表面處理

鍍錫

Suitable Housing: PD24215P2~PD24215P20

配合塑膠

PDK24215P2~PDK24215P20

MD24215P2~MD24215P20

MD24215P2R~MD24215P20R

MDK24215P3~MDK24215P20

Packing: 10,000PCS(Reel)

包裝數量

PERFORMANCE

Electrical Rating: AC/DC 250V 2A

額定電壓電流

Insulation Resistance: 1000MΩ min.

絕緣阻抗

Withstanding Voltage: 800V AC/minute

耐電壓

Temperature Range: -25°C~+85°C

適用溫度



For wire range 24~28 AWG:
P/No. 24215PS-2

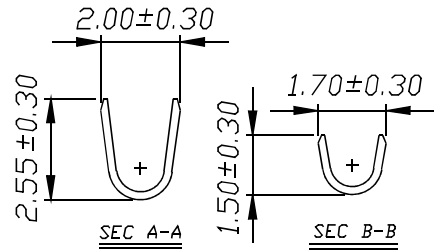

For wire range 28~30 AWG:
P/No. 24215PS-2 RF:B

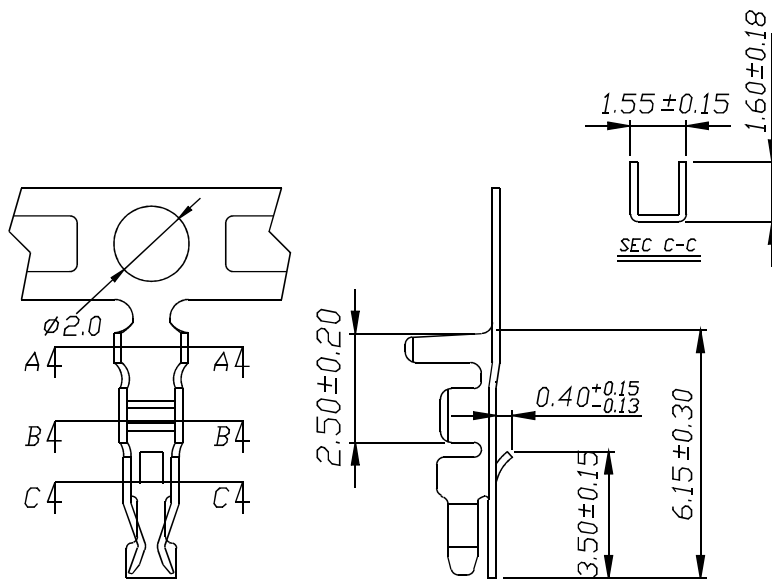
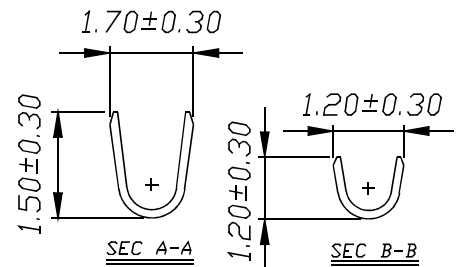

Notes

Item	Description
Suitable Connector 配合公座	MD24215P2~MD24215P20 MD24215P2~MD24215P20 RF:A MD24215P2R~MD24215P20R MD24215P2R~MD24215P17R RF:A MDK24215P3~MDK24215P20
Suitable Housing 配合塑膠	PD24215P2~PD24215P20 PDK24215P3~PDK24215P20
Suitable Wire 適用電線	24215PS-2 AWG#24~28 (1.2~1.6mm) 24215PS-2 RF:B AWG#28~30 (0.8~0.7mm)

2.0mm