

2401

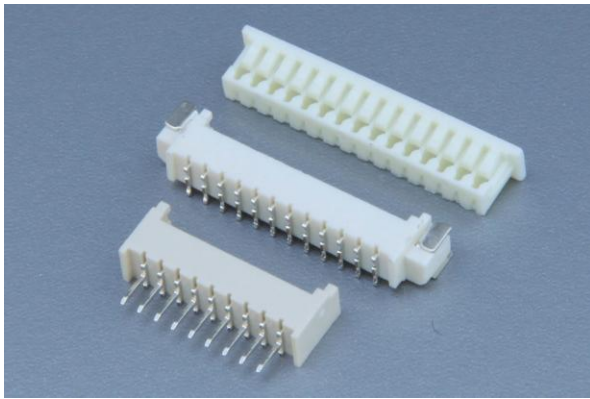

Pitch 1.25mm Wire to Board Connectors - SMT Type



PERFORMANCE

Electrical Rating: AC/DC 500V 1A
 額定電壓電流
 Insulation Resistance: 500MΩ min.
 絕緣阻抗
 Withstanding Voltage: 500V AC/minute
 耐電壓
 Temperature Range: -25°C~+85°C
 適用溫度



1.25mm

CONNECTOR - Top Entry

Part No.: MS24012~MS240115

產品編號

Material: Housing: Nylon 94V-0

材質 塑膠座

Contact Pin: Brass, Tin-plated

接觸針 黃銅, 鍍錫

Suitable Contact: 2401PS-2

配合端子

Suitable Housing: P24012~P240115

配合塑膠

Applicable Wire: AWG# 28~32

適用電線

Square Contact Pin: 0.30±0.02mm

方型接觸針

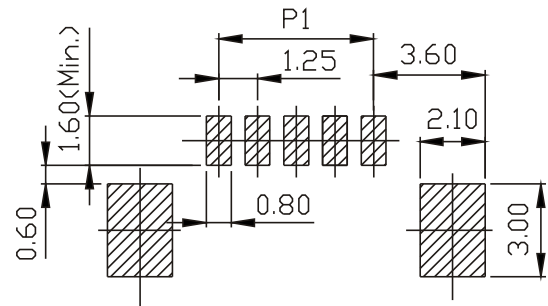
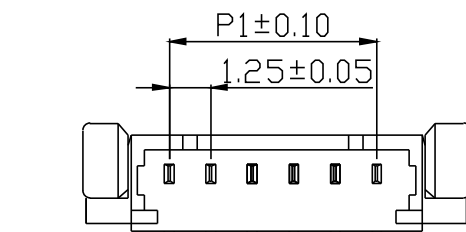
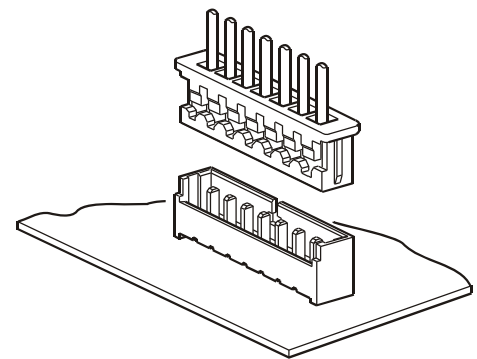

P.C.B LAYOUT

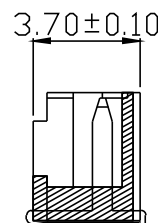
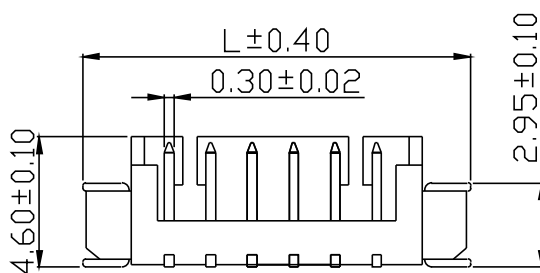

Unit: mm

PartNo.	POS.	L	P1	Pack.	PartNo.	POS.	L	P1	Pack.
MS24012	2	7.65	1.25	500	MS24019	9	16.40	10.00	500
MS24013	3	8.90	2.50	500	MS240110	10	17.65	11.25	500
MS24014	4	10.15	3.75	500	MS240111	11	18.90	12.50	500
MS24015	5	11.40	5.00	500	MS240112	12	20.15	13.75	500
MS24016	6	12.65	6.25	500	MS240113	13	21.40	15.00	500
MS24017	7	13.90	7.50	500	MS240114	14	22.65	16.25	500
MS24018	8	15.15	8.75	500	MS240115	15	23.90	17.50	500

Behave in conformity with continual product development policy, SinSheng (STM) reserves the right of specification changing of contents described in this catalogue at any time and without prior notice. Please contact the sales department nearby for most updated information.
 由於產品持續開發的政策, 信盛(STM)保留隨時變更本目錄所述之規格且不需提前通知的權利。請連繫業務處查詢最新的產品資訊。

2401 Wire to Board Connectors - SMT Type



CONNECTOR - Top Entry

Part No.: **MS24012~MS240115 RF:HD**

產品編號

Material: Housing: Nylon 94V-0

材質 塑膠座

Contact Pin: Brass, Tin-plated

接觸針 黃銅, 鍍錫

Suitable Contact: 2401PS-2

配合端子

Suitable Housing: P24012~P240115

配合塑膠

Applicable Wire: AWG# 28~32

適用電線

Square Contact Pin: 0.30±0.02mm

方型接觸針

PERFORMANCE

Electrical Rating: AC/DC 125V 1A

額定電壓電流

Insulation Resistance: 100MΩ min.

絕緣阻抗

Withstanding Voltage: 250V AC/minute

耐電壓

Temperature Range: -25°C~+85°C

適用溫度



1.25mm

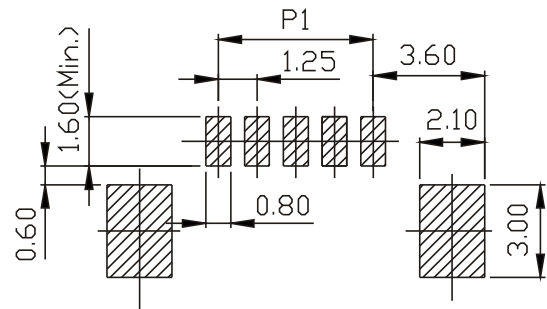
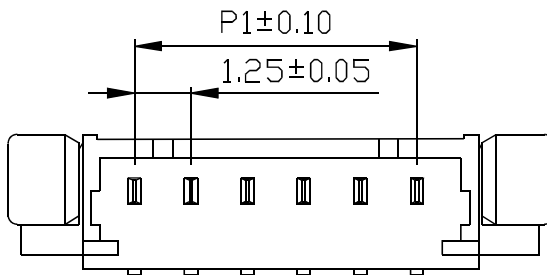

P.C.B LAYOUT

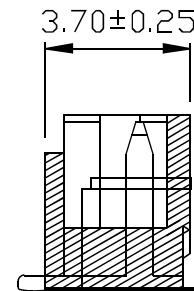
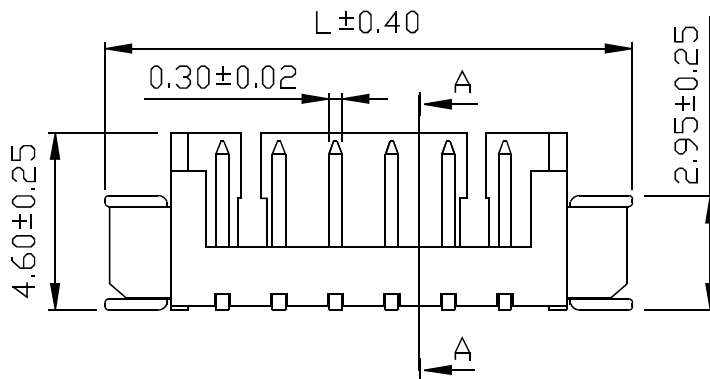

Note: Letters RF:HD to be added follows the part number, i.e MS24012RF:HD.

Unit: mm

PartNo.	POS.	L	P1	Pack.	PartNo.	POS.	L	P1	Pack.
MS24012	2	7.65	1.25	1,000	MS24019	9	16.40	10.00	1,000
MS24013	3	8.90	2.50	1,000	MS240110	10	17.65	11.25	1,000
MS24014	4	10.15	3.75	1,000	MS240111	11	18.90	12.50	1,000
MS24015	5	11.40	5.00	1,000	MS240112	12	20.15	13.75	1,000
MS24016	6	12.65	6.25	1,000	MS240113	13	21.40	15.00	1,000
MS24017	7	13.90	7.50	1,000	MS240114	14	22.65	16.25	1,000
MS24018	8	15.15	8.75	1,000	MS240115	15	23.90	17.50	1,000

2401 Wire to Board Connectors - SMT Type



CONNECTOR - Side Entry

Part No.: **MS24012R~MS240115R**

產品編號

Material: Housing: Nylon 94V-0

材質 塑膠座

Contact Pin: Brass, Tin-plated

接觸針 黃銅, 鍍錫

Suitable Contact: 2401PS-2

配合端子

Suitable Housing: P24012~P240115

配合塑膠

Applicable Wire: AWG# 28~32

適用電線

Square Contact Pin: 0.30±0.02mm

方型接觸針

PERFORMANCE

Electrical Rating: AC/DC 500V 1A

額定電壓電流

Insulation Resistance: 500MΩ min.

絕緣阻抗

Withstanding Voltage: 500V AC/minute

耐電壓

Temperature Range: -25°C~+85°C

適用溫度



1.25mm

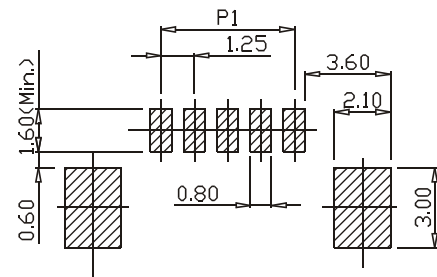
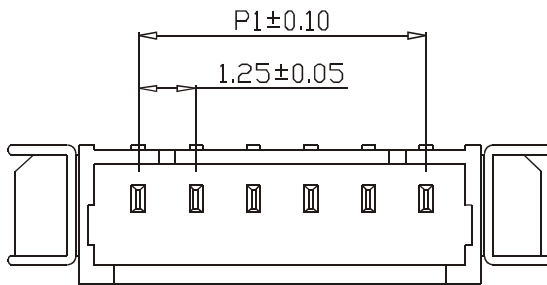

P.C.B LAYOUT

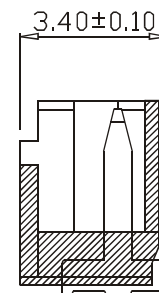
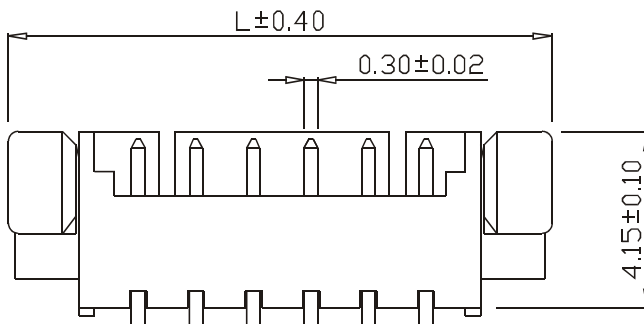

Unit: mm

Part No.	POS.	L	P1	Pack.	Part No.	POS.	L	P1	Pack.
MS24012R	2	7.65	1.25	500	MS24019R	9	16.40	10.00	500
MS24013R	3	8.90	2.50	500	MS240110R	10	17.65	11.25	500
MS24014R	4	10.15	3.75	500	MS240111R	11	18.90	12.50	500
MS24015R	5	11.40	5.00	500	MS240112R	12	20.15	13.75	500
MS24016R	6	12.65	6.25	500	MS240113R	13	21.40	15.00	500
MS24017R	7	13.90	7.50	500	MS240114R	14	22.65	16.25	500
MS24018R	8	15.15	8.75	500	MS240115R	15	23.90	17.50	500

2401 Wire to Board Connectors - SMT Type



CONNECTOR - Side Entry

Part No.: **MS24012R~MS240115R RF:HD**

產品編號

Material: Housing: Nylon 94V-0

材質 塑膠座

Contact Pin: Brass, Tin-plated

接觸針 黃銅, 鍍錫

Suitable Contact: 2401PS-2

配合端子

Suitable Housing: P24012~P240115

配合塑膠

Applicable Wire: AWG# 28~32

適用電線

Square Contact Pin: 0.30±0.02mm

方型接觸針

PERFORMANCE

Electrical Rating: AC/DC 120V 1A

額定電壓電流

Insulation Resistance: 100MΩ min.

絕緣阻抗

Withstanding Voltage: 250V AC/minute

耐電壓

Temperature Range: -25°C~+85°C

適用溫度



1.25mm

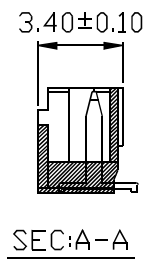
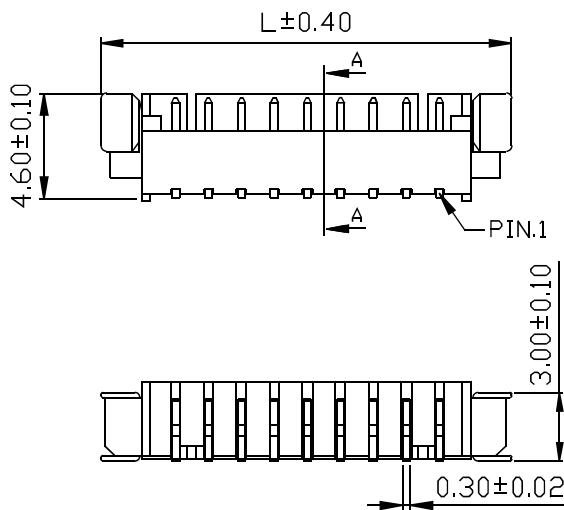
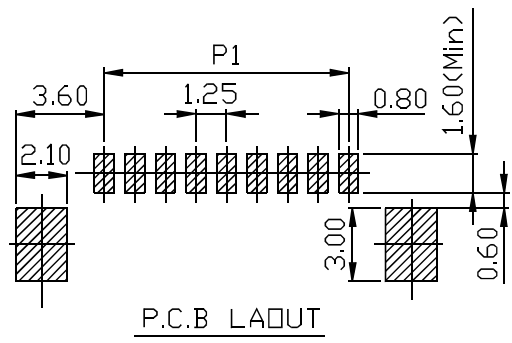
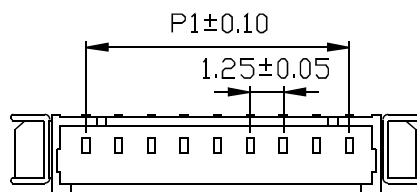

Note: Letters RF:HD to be added follows the part number, i.e MS24012R RF:HD.

Unit: mm

Part No.	POS.	L	P1	Pack.	Part No.	POS.	L	P1	Pack.
MS24012R	2	7.65	1.25	1,000	MS24019R	9	16.40	10.00	1,000
MS24013R	3	8.90	2.50	1,000	MS240110R	10	17.65	11.25	1,000
MS24014R	4	10.15	3.75	1,000	MS240111R	11	18.90	12.50	1,000
MS24015R	5	11.40	5.00	1,000	MS240112R	12	20.15	13.75	1,000
MS24016R	6	12.65	6.25	1,000	MS240113R	13	21.40	15.00	1,000
MS24017R	7	13.90	7.50	1,000	MS240114R	14	22.65	16.25	1,000
MS24018R	8	15.15	8.75	1,000	MS240115R	15	23.90	17.50	1,000

2401 Wire to Board Connectors



CONNECTOR - Top Entry

Part No.: **M24012~M240115**

產品編號

Material: Housing: Nylon 94V-0

材質 塑膠座

Contact Pin: Brass, Tin-plated

接觸針 黃銅, 鍍錫

Suitable Contact: 2401PS-2

配合端子

Suitable Housing: P24012~P240115

配合塑膠

Applicable Wire: AWG#28~32

適用電線

Square Contact Pin: 0.30±0.02mm

方型接觸針

PERFORMANCE

Electrical Rating: AC/DC 100V 1A

額定電壓電流

Insulation Resistance: 500MΩ min.

絕緣阻抗

Withstanding Voltage: 500V AC/minute

耐電壓

Temperature Range: -25°C~+85°C

適用溫度



1.25mm

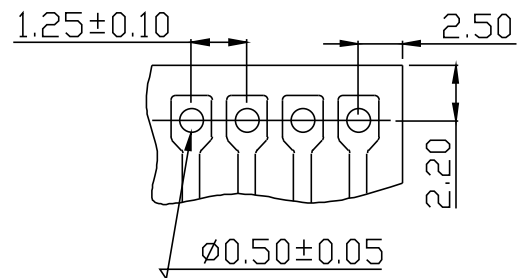
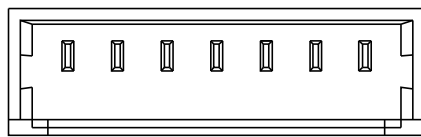

P.C.B LAYOUT

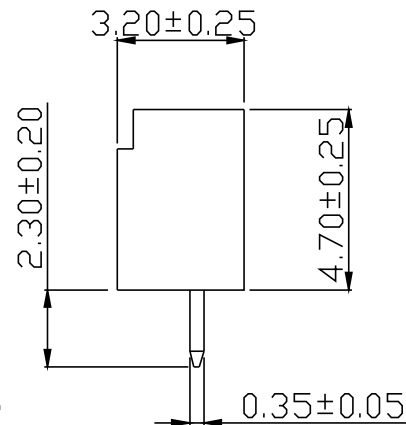
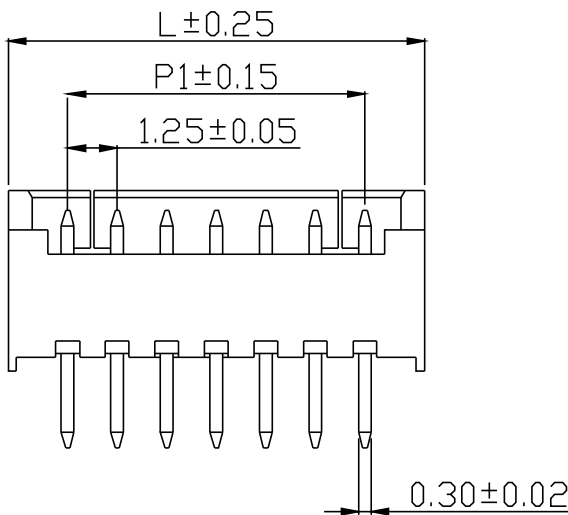

Unit: mm

Part No.	POS.	L	P1	Pack.	Part No.	POS.	L	P1	Pack.
M24012	2	4.25	1.25	500	M24019	9	13.00	10.00	500
M24013	3	5.50	2.50	500	M240110	10	14.25	11.25	500
M24014	4	6.75	3.75	500	M240111	11	15.50	12.50	500
M24015	5	8.00	5.00	500	M240112	12	16.75	13.75	500
M24016	6	9.25	6.25	500	M240113	13	18.00	15.00	500
M24017	7	10.50	7.50	500	M240114	14	19.25	16.25	500
M24018	8	11.75	8.75	500	M240115	15	20.50	17.50	500

2401 Wire to Board Connectors



CONNECTOR - Side Entry

Part No.: **M24012R~M240115R**

產品編號

Material: Housing: Nylon 94V-0

材質 塑膠座

Contact Pin: Brass, Tin-plated

接觸針 黃銅, 鍍金

Suitable Contact: 2401PS-2

配合端子

Suitable Housing: P24012~P240115

配合塑膠

Applicable Wire: AWG# 28~32

適用電線

Square Contact Pin: 0.30±0.02mm

方型接觸針

PERFORMANCE

Electrical Rating: AC/DC 100V 1A

額定電壓電流

Insulation Resistance: 500MΩ min.

絕緣阻抗

Withstanding Voltage: 500V AC/minute

耐電壓

Temperature Range: -25°C~+85°C

適用溫度



1.25mm

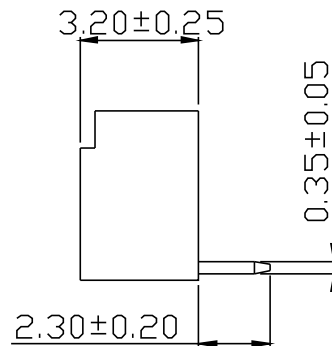
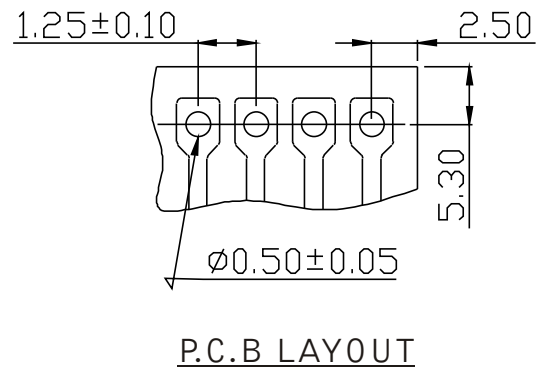
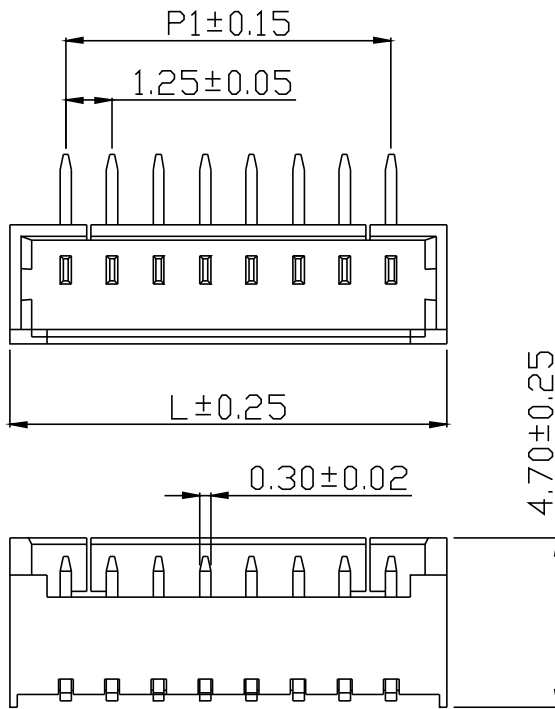

Unit: mm

PartNo.	POS.	L	P1	Pack.	PartNo.	POS.	L	P1	Pack.
M24012R	2	4.25	1.25	500	M24019R	9	13.00	10.00	500
M24013R	3	5.50	2.50	500	M240110R	10	14.25	11.25	500
M24014R	4	6.75	3.75	500	M240111R	11	15.50	12.50	500
M24015R	5	8.00	5.00	500	M240112R	12	16.75	13.75	500
M24016R	6	9.25	6.25	500	M240113R	13	18.00	15.00	500
M24017R	7	10.50	7.50	500	M240114R	14	19.25	16.25	500
M24018R	8	11.75	8.75	500	M240115R	15	20.50	17.50	500

2401 Wire to Board Connectors



HOUSING

Part No.: **P24012~P240115**

產品編號

Material: P.B.T 94V-0

材質

Suitable Contact: 2401PS-2

配合端子

Suitable Connector: M24012~M240115

配合公座

M24012R~M240115R

MS24012~MS240115

MS24012R~MS240115R

Applicable Wire: AWG# 28~32

適用電線

PERFORMANCE

Electrical Rating: AC/DC 250V 1A

額定電壓電流

Insulation Resistance: 100MΩ min.

絕緣阻抗

Withstanding Voltage: 250V AC/minute

耐電壓

Temperature Range: -40°C~+85°C

適用溫度



1.25mm

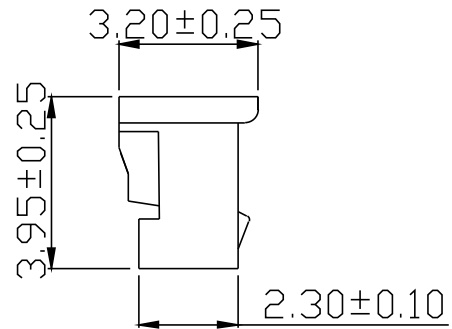
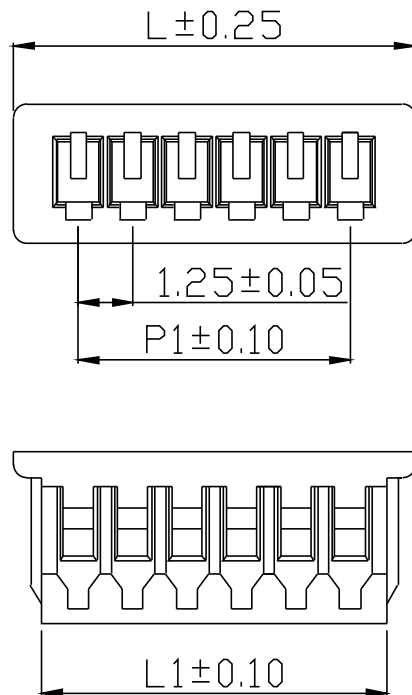

Unit: mm

Part No.	POS.	L	L1	P1	Pack.	Part No.	POS.	L	L1	P1	Pack.
P24012	2	4.25	2.95	1.25	1000	P24019	9	13.00	11.70	10.00	500
P24013	3	5.50	4.20	2.50	1000	P240110	10	14.25	12.95	11.25	500
P24014	4	6.75	5.45	3.75	1000	P240111	11	15.50	14.20	12.50	500
P24015	5	8.00	6.70	5.00	1000	P240112	12	16.75	15.45	13.75	500
P24016	6	9.25	7.95	6.25	1000	P240113	13	18.00	16.70	15.00	500
P24017	7	10.50	9.20	7.50	500	P240114	14	19.25	17.95	16.25	500
P24018	8	11.75	10.45	8.75	500	P240115	15	20.50	19.20	17.50	500

2401 Wire to Board Connectors

TERMINAL

Part No.: **2401PS-2**

產品編號

Thickness: 0.15mm

銅板厚度

Material: Phosphor Bronze

材質 磷青銅

Surface Treatment: Tin-plated

表面處理 鍍錫

Applicable Wire: AWG# 28~32

適用電線

Insulation O.D.: 0.60~1.00mm

線皮外徑

Suitable Housing: P24012~P240115

配合塑膠

Suitable Connector: M24012~M240115

配合公座

M24012R~M240115R

MS24012~MS240115

MS24012R~MS240115R

Packing: 20,000PCS(Reel)

包裝數量

PERFORMANCE

Electrical Rating: AC/DC 250V 1A

額定電壓電流

Insulation Resistance: 100MΩ min.

絕緣阻抗

Withstanding Voltage: 250V AC/minute

耐電壓

Temperature Range: -40°C~+85°C

適用溫度



1.25mm

