

# 2402

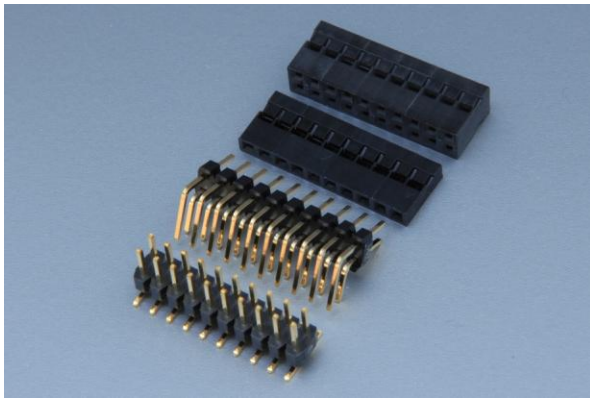

## Pitch 2.0mm Wire to Board Connectors - SMT Type



### PERFORMANCE

Electrical Rating: AC/DC 250V 1A  
 額定電壓電流  
 Insulation Resistance: 500MΩ min.  
 絕緣阻抗  
 Withstanding Voltage: 500V AC/minute  
 耐電壓  
 Temperature Range: -40°C~+105°C  
 適用溫度



### CONNECTOR - Top Entry

Part No.: MS24022~MS240240

產品編號

Material: Housing: Nylon 94V-2, Black

材質 塑膠座 黑色

Contact Pin : Brass, Gold-flash

接觸針 黃銅 鍍金

Suitable Contact: : 2402PS-2 2402PS-00

配合端子

Suitable Housing: P24022~P240240

配合塑膠

Applicable Wire: AWG# 26~30

適用電線

Square Contact Pin : 0.50±0.02mm

方型接觸針

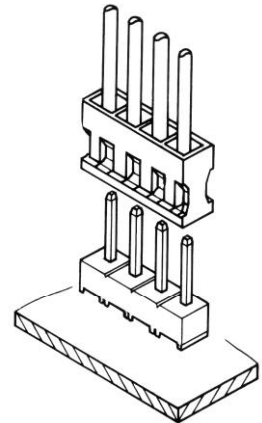

2.0mm

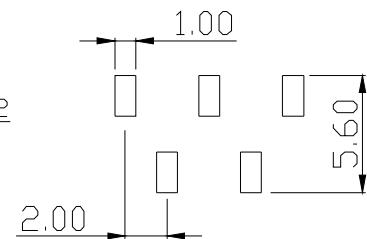
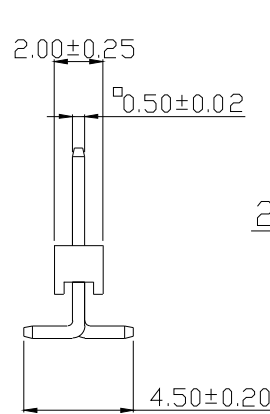
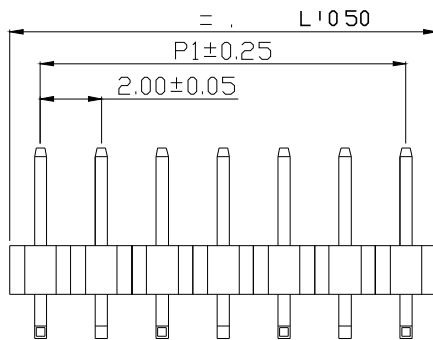

P.C.B LAYOUT

Unit: mm

Part No.	POS.	L	P1	Pack.	Part No.	POS.	L	P1	Pack.	Part No.	POS.	L	P1	Pack.
MS24022	2	4.00	2.00	1000	MS240215	15	30.00	28.00	1000	MS240228	28	56.00	54.00	300
MS24023	3	6.00	4.00	1000	MS240216	16	32.00	30.00	500	MS240229	29	58.00	56.00	300
MS24024	4	8.00	6.00	1000	MS240217	17	34.00	32.00	500	MS240230	30	60.00	58.00	300
MS24025	5	10.00	8.00	1000	MS240218	18	36.00	34.00	500	MS240231	31	62.00	60.00	300
MS24026	6	12.00	10.00	1000	MS240219	19	38.00	36.00	500	MS240232	32	64.00	62.00	300
MS24027	7	14.00	12.00	1000	MS240220	20	40.00	38.00	500	MS240233	33	66.00	64.00	300
MS24028	8	16.00	14.00	1000	MS240221	21	42.00	40.00	500	MS240234	34	68.00	66.00	300
MS24029	9	18.00	16.00	1000	MS240222	22	44.00	42.00	500	MS240235	35	70.00	68.00	300
MS240210	10	20.00	18.00	1000	MS240223	23	46.00	44.00	500	MS240236	36	72.00	70.00	300
MS240211	11	22.00	20.00	1000	MS240224	24	48.00	46.00	500	MS240237	37	74.00	72.00	300
MS240212	12	24.00	22.00	1000	MS240225	25	50.00	48.00	300	MS240238	38	76.00	74.00	300
MS240213	13	26.00	24.00	1000	MS240226	26	52.00	50.00	300	MS240239	39	78.00	76.00	300
MS240214	14	28.00	26.00	1000	MS240227	27	54.00	52.00	300	MS240240	40	80.00	78.00	300

Behave in conformity with continual product development policy, SinSheng (STM) reserves the right of specification changing of contents described in this catalogue any time and without prior notice. Please contact the sales department nearby for most updated information.  
 由於產品持續開發的政策, 信盛(STM)保留隨時變更本目錄所述之規格且不需提前通知的權利. 請連繫業務處查詢最新的產品資訊.

# 2402 Wire to Board Connectors - SMT Type



## CONNECTOR - Top Entry

Part No.: MDS24022~MDS240240

產品編號

Material: Housing: Nylon 94V-2, Black

材質

塑膠座

Contact Pin : Brass, Gold-flash

接觸針

黃銅

鍍金

Suitable Contact: : 2402PS-2 2402PS-00

配合端子

Suitable Housing: PD24022~PD240240

配合塑膠

Applicable Wire: AWG# 26~30

適用電線

Square Contact Pin : 0.50±0.02mm

方型接觸針

## PERFORMANCE

Electrical Rating: AC/DC 250V 1A

額定電壓電流

Insulation Resistance: 500MΩ min.

絕緣阻抗

Withstanding Voltage: 500V AC/minute

耐電壓

Temperature Range: -40°C~+105°C

適用溫度

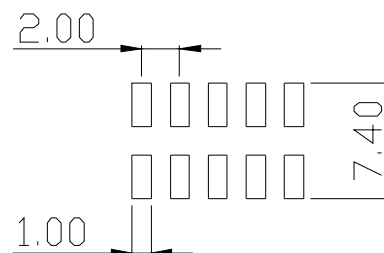

## P.C.B LAYOUT

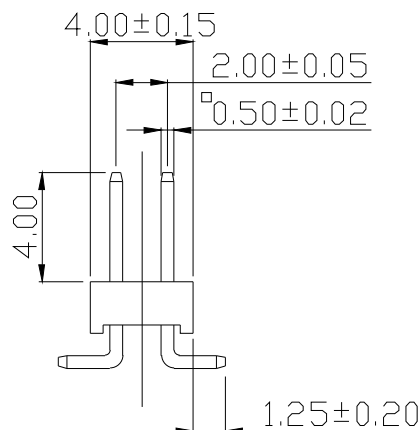
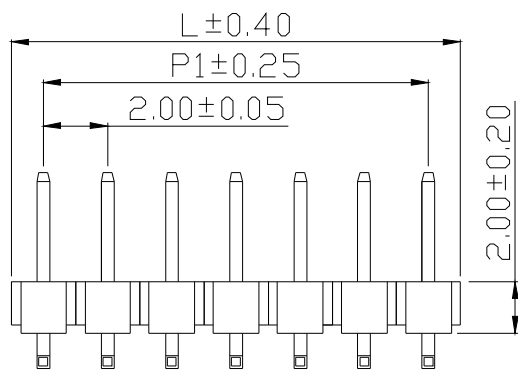

Part No.	POS.	L	P1	Pack.
MDS24022	2X2	4.00	2.00	1000
MDS24023	2X3	6.00	4.00	1000
MDS24024	2X4	8.00	6.00	1000
MDS24025	2X5	10.00	8.00	1000
MDS24026	2X6	12.00	10.00	1000
MDS24027	2X7	14.00	12.00	1000
MDS24028	2X8	16.00	14.00	1000
MDS24029	2X9	18.00	16.00	1000
MDS240210	2X10	20.00	18.00	1000
MDS240211	2X11	22.00	20.00	500
MDS240212	2X12	24.00	22.00	500
MDS240213	2X13	26.00	24.00	500
MDS240214	2X14	28.00	26.00	500

Part No.	POS.	L	P1	Pack.
MDS240215	2X15	30.00	28.00	500
MDS240216	2X16	32.00	30.00	500
MDS240217	2X17	34.00	32.00	500
MDS240218	2X18	36.00	34.00	500
MDS240219	2X19	38.00	36.00	500
MDS240220	2X20	40.00	38.00	500
MDS240221	2X21	42.00	40.00	300
MDS240222	2X22	44.00	42.00	300
MDS240223	2X23	46.00	44.00	300
MDS240224	2X24	48.00	46.00	300
MDS240225	2X25	50.00	48.00	300
MDS240226	2X26	52.00	50.00	300
MDS240227	2X27	54.00	52.00	300

Part No.	POS.	L	P1	Pack.
MDS240228	2X28	56.00	54.00	300
MDS240229	2X29	58.00	56.00	300
MDS240230	2X30	60.00	58.00	300
MDS240231	2X31	62.00	60.00	300
MDS240232	2X32	64.00	62.00	300
MDS240233	2X33	66.00	64.00	300
MDS240234	2X34	68.00	66.00	300
MDS240235	2X35	70.00	68.00	300
MDS240236	2X36	72.00	70.00	300
MDS240237	2X37	74.00	72.00	300
MDS240238	2X38	76.00	74.00	300
MDS240239	2X39	78.00	76.00	300
MDS240240	2X40	80.00	78.00	300

Unit: mm

2.0mm

# 2402 Wire to Board Connectors - DIP Type



## CONNECTOR - Top Entry

Part No.: MF24023~MF240240

產品編號

Material: Housing: Nylon 94V-0, Black

材質 塑膠座 黑色

Suitable Contact: : 2402PS-2 2402PS-00

配合端子

Suitable Housing: M24023~M240240

配合塑膠

Applicable Wire: AWG# 26~30

適用電線

Square Contact Pin : 0.50±0.20mm

方型接觸針

## PERFORMANCE

Electrical Rating: AC/DC 250V 1A

額定電壓電流

Insulation Resistance: 5000MΩ min.

絕緣阻抗

Withstanding Voltage: 500V AC/minute

耐電壓

Temperature Range: -40°C~+105°C

適用溫度

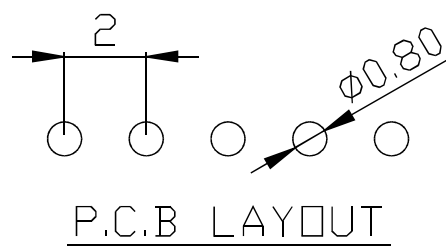
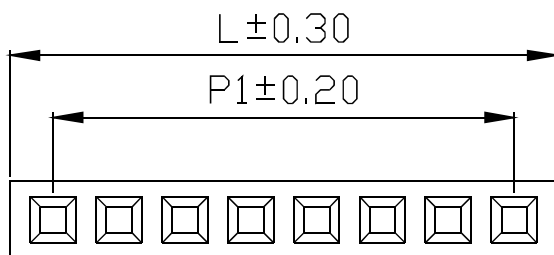

2.0mm

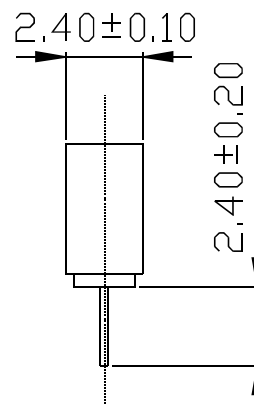
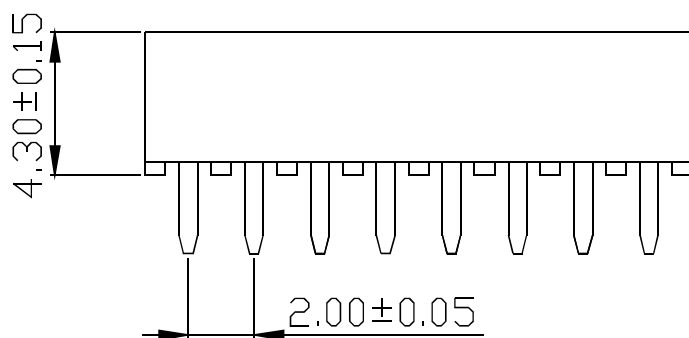

Unit: mm

Part No.	POS.	L	P1
MF24023	3	6.50	4.00
MF24024	4	8.50	6.00
MF24025	5	10.50	8.00
MF24026	6	12.50	10.00
MF24027	7	14.50	12.00
MF24028	8	16.50	14.00
MF24029	9	18.50	16.00
MF240210	10	20.50	18.00
MF240211	11	22.50	20.00
MF240212	12	24.50	22.00
MF240213	13	26.50	24.00
MF240214	14	28.50	26.00
MF240215	15	30.50	28.00

Part No.	POS.	L	P1
MF240216	16	32.50	30.00
MF240217	17	34.50	32.00
MF240218	18	36.50	34.00
MF240219	19	38.50	36.00
MF240220	20	40.50	38.00
MF240221	21	42.50	40.00
MF240222	22	44.50	42.00
MF240223	23	46.50	44.00
MF240224	24	48.50	46.00
MF240225	25	50.50	48.00
MF240226	26	52.50	50.00
MF240227	27	54.50	52.00
MF240228	28	56.50	54.00

Part No.	POS.	L	P1
MF240229	29	58.50	56.00
MF240230	30	60.50	58.00
MF240231	31	62.50	60.00
MF240232	32	64.50	62.00
MF240233	33	66.50	64.00
MF240234	34	68.50	66.00
MF240235	35	70.50	68.00
MF240236	36	72.50	70.00
MF240237	37	74.50	72.00
MF240238	38	76.50	74.00
MF240239	39	78.50	76.00
MF240240	40	80.50	78.00

# 2402 Wire to Board Connectors - DIP Type

## CONNECTOR - Side Entry

Part No.: MF24023R~MF240240R

產品編號

Material: Housing: P.B.T 94V-0, Black

材質 塑膠座 黑色

Suitable Contact: : 2402PS-2 2402PS-00

配合端子

Suitable Housing: M24023R~M240240R

配合塑膠

Applicable Wire: AWG# 26~30

適用電線

Square Contact Pin : 0.50±0.20mm

方型接觸針

## PERFORMANCE

Electrical Rating: AC/DC 250V 1A

額定電壓電流

Insulation Resistance: 5000MΩ min.

絕緣阻抗

Withstanding Voltage: 500V AC/minute

耐電壓

Temperature Range: -40°C~+105°C

適用溫度



2.0mm

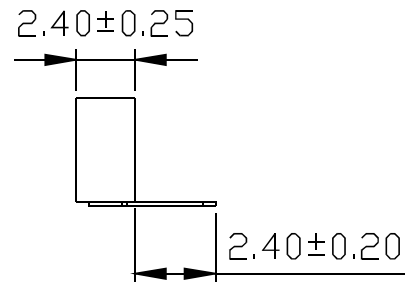
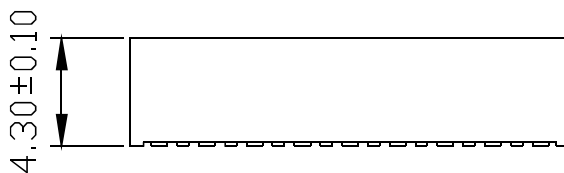
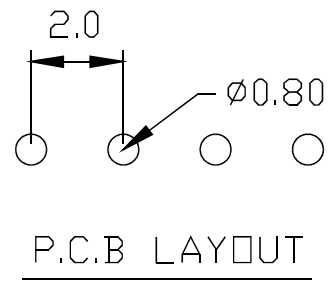
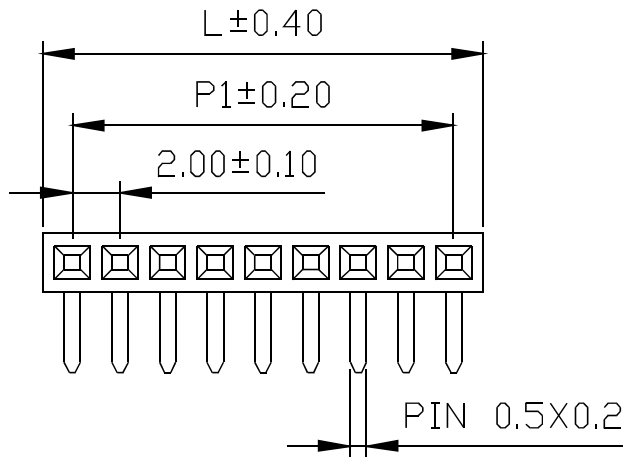

Part No.	POS.	L	P1
MF24023R	3	6.50	4.00
MF24024R	4	8.50	6.00
MF24025R	5	10.50	8.00
MF24026R	6	12.50	10.00
MF24027R	7	14.50	12.00
MF24028R	8	16.50	14.00
MF24029R	9	18.50	16.00
MF240210R	10	20.50	18.00
MF240211R	11	22.50	20.00
MF240212R	12	24.50	22.00
MF240213R	13	26.50	24.00
MF240214R	14	28.50	26.00
MF240215R	15	30.50	28.00

Part No.	POS.	L	P1
MF240216R	16	32.50	30.00
MF240217R	17	34.50	32.00
MF240218R	18	36.50	34.00
MF240219R	19	38.50	36.00
MF240220R	20	40.50	38.00
MF240221R	21	42.50	40.00
MF240222R	22	44.50	42.00
MF240223R	23	46.50	44.00
MF240224R	24	48.50	46.00
MF240225R	25	50.50	48.00
MF240226R	26	52.50	50.00
MF240227R	27	54.50	52.00
MF240228R	28	56.50	54.00

Part No.	POS.	L	P1
MF240229R	29	58.50	56.00
MF240230R	30	60.50	58.00
MF240231R	31	62.50	60.00
MF240232R	32	64.50	62.00
MF240233R	33	66.50	64.00
MF240234R	34	68.50	66.00
MF240235R	35	70.50	68.00
MF240236R	36	72.50	70.00
MF240237R	37	74.50	72.00
MF240238R	38	76.50	74.00
MF240239R	39	78.50	76.00
MF240240R	40	80.50	78.00

Unit: mm

# 2402 Wire to Board Connectors - DIP Type



## CONNECTOR - Top Entry

Part No.: **MDF24022~MDF240240**

產品編號

Material: Housing: Nylon 94V-0, Black

材質

塑膠座

黑色

Contact Pin : Brass, Tin-plated

接觸針

黃銅,

鍍錫

Suitable Contact: : 2402PS-2 2402PS-00

配合端子

Suitable Housing: MD24022~MD240240

配合塑膠

Applicable Wire: AWG# 26~30

適用電線

Square Contact Pin : 0.50±0.20mm

方型接觸針

## PERFORMANCE

Electrical Rating: AC/DC 250V 1A

額定電壓電流

Insulation Resistance: 5000MΩ min.

絕緣阻抗

Withstanding Voltage: 500V AC/minute

耐電壓

Temperature Range: -40°C~+105°C

適用溫度

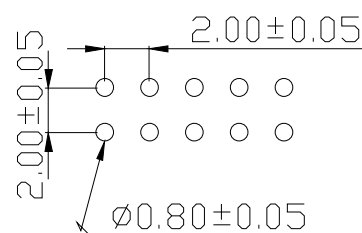
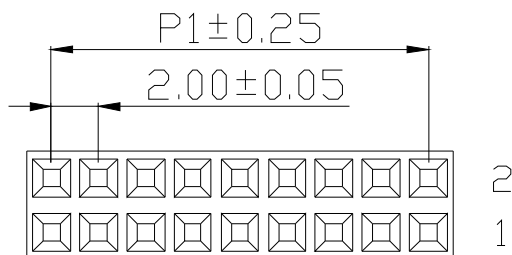

P.C.B LAYOUT

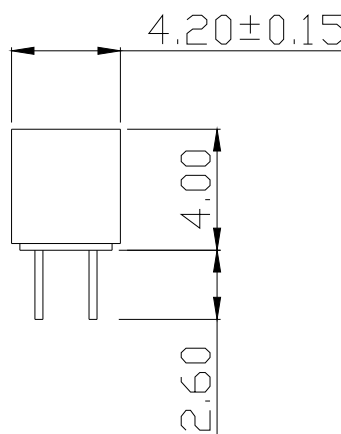
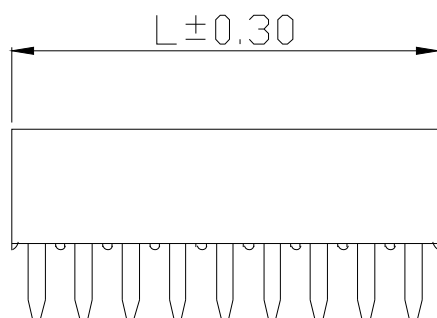

2.0mm

Unit: mm

Part No.	POS.	L	P1	Pack.	Part No.	POS.	L	P1	Pack.	Part No.	POS.	L	P1	Pack.
MDF24022	2X2	4.60	2.00	1000	MDF240215	2X15	30.60	28.00	500	MDF240228	2X28	56.60	54.00	300
MDF24023	2X3	6.60	4.00	1000	MDF240216	2X16	32.60	30.00	500	MDF240229	2X29	58.60	56.00	300
MDF24024	2X4	8.60	6.00	1000	MDF240217	2X17	34.60	32.00	500	MDF240230	2X30	60.60	58.00	300
MDF24025	2X5	10.60	8.00	1000	MDF240218	2X18	36.60	34.00	500	MDF240231	2X31	62.60	60.00	300
MDF24026	2X6	12.60	10.00	1000	MDF240219	2X19	38.60	36.00	500	MDF240232	2X32	64.60	62.00	300
MDF24027	2X7	14.60	12.00	1000	MDF240220	2X20	40.60	38.00	500	MDF240233	2X33	66.60	64.00	300
MDF24028	2X8	16.60	14.00	1000	MDF240221	2X21	42.60	40.00	300	MDF240234	2X34	68.60	66.00	300
MDF24029	2X9	18.60	16.00	1000	MDF240222	2X22	44.60	42.00	300	MDF240235	2X35	70.60	68.00	300
MDF240210	2X10	20.60	18.00	1000	MDF240223	2X23	46.60	44.00	300	MDF240236	2X36	72.60	70.00	300
MDF240211	2X11	22.60	20.00	500	MDF240224	2X24	48.60	46.00	300	MDF240237	2X37	74.60	72.00	300
MDF240212	2X12	24.60	22.00	500	MDF240225	2X25	50.60	48.00	300	MDF240238	2X38	76.60	74.00	300
MDF240213	2X13	26.60	24.00	500	MDF240226	2X26	52.60	50.00	300	MDF240239	2X39	78.60	76.00	300
MDF240214	2X14	28.60	26.00	500	MDF240227	2X27	54.60	52.00	300	MDF240240	2X40	80.60	78.00	300

# 2402 Wire to Board Connectors - DIP Type

## CONNECTOR - Top Entry

Part No.: MDF24022~MDF240240 RF:B

產品編號

Material: Housing: Nylon 94V-0, Black

材質

塑膠座

黑色

Contact Pin : Brass, Tin-plated

接觸針

黃銅

鍍錫

Suitable Contact: : 2402PS-2 2402PS-00

配合端子

Suitable Housing: MD24022~MD240240

配合塑膠

Applicable Wire: AWG# 26~30

適用電線

Square Contact Pin : 0.50±0.20mm

方型接觸針

## PERFORMANCE

Electrical Rating: AC/DC 250V 2A

額定電壓電流

Insulation Resistance: 1000MΩ min.

絕緣阻抗

Withstanding Voltage: 500V AC/minute

耐電壓

Temperature Range: -40°C~+105°C

適用溫度

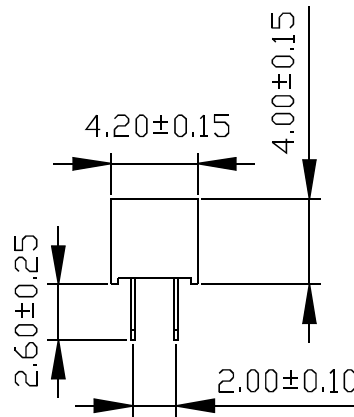
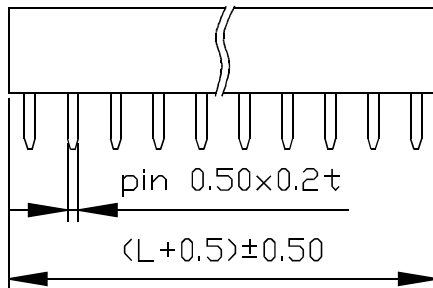
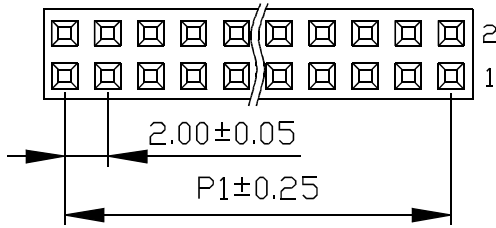
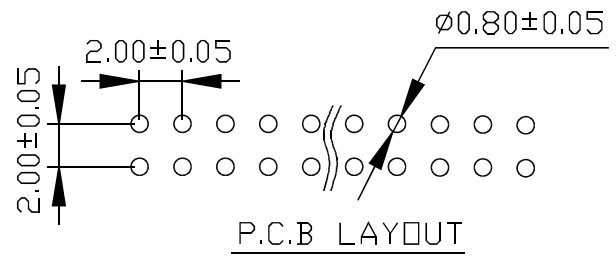

TOLERANCE	
.0	±0.20
.00	±0.15

Unit: mm

Part No.	RF	POS	L	P1	Pack.
MDF24022	B	2X2	4.00	2.00	1000/Box
MDF240220	B	2X20	40.00	38.00	100/Tray
MDF240240	B	2X40	80.00	78.00	60/Tray

2.0mm

# 2402 Wire to Board Connectors - DIP Type

## CONNECTOR - Side Entry

Part No.: **MDF24022R~MDF240240R**

產品編號

Material: Housing: Nylon 94V-0, Black

材質 塑膠座 黑色

Contact Pin : Brass, Tin-plated

接觸針 黃銅, 鍍錫

Suitable Contact: : 2402PS-2 2402PS-00

配合端子

Suitable Housing: MD24022~MD240240

配合塑膠

MD24022R~MD240240R

Applicable Wire: AWG# 26~30

適用電線

Square Contact Pin : 0.50±0.03mm

方型接觸針

## PERFORMANCE

Electrical Rating: AC/DC 250V 1A

額定電壓電流

Insulation Resistance: 500MΩ min.

絕緣阻抗

Withstanding Voltage: 500V AC/minute

耐電壓

Temperature Range: -40°C~+105°C

適用溫度

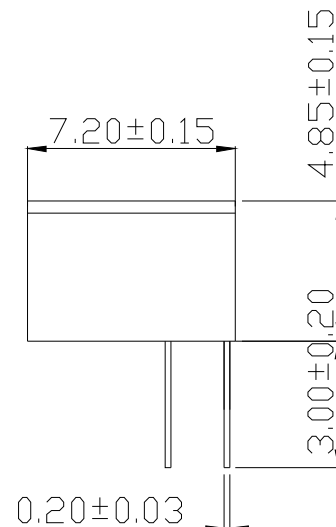
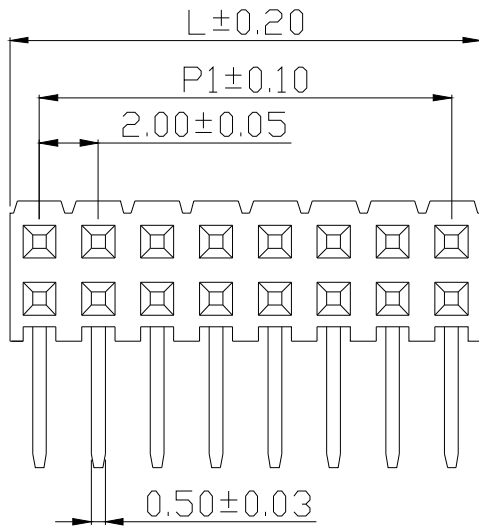
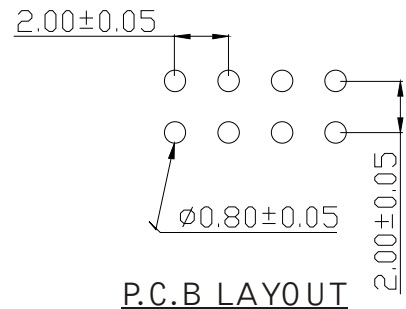

2.0mm

Unit: mm

Part No.	POS.	L	P1	Pack.	Part No.	POS.	L	P1	Pack.	Part No.	POS.	L	P1	Pack.
MDF24022R	2X2	4.60	2.00	1000	MDF240215R	2X15	30.60	28.00	500	MDF240228R	2X28	56.60	54.00	300
MDF24023R	2X3	6.60	4.00	1000	MDF240216R	2X16	32.60	30.00	500	MDF240229R	2X29	58.60	56.00	300
MDF24024R	2X4	8.60	6.00	1000	MDF240217R	2X17	34.60	32.00	500	MDF240230R	2X30	60.60	58.00	300
MDF24025R	2X5	10.60	8.00	1000	MDF240218R	2X18	36.60	34.00	500	MDF240231R	2X31	62.60	60.00	300
MDF24026R	2X6	12.60	10.00	1000	MDF240219R	2X19	38.60	36.00	500	MDF240232R	2X32	64.60	62.00	300
MDF24027R	2X7	14.60	12.00	1000	MDF240220R	2X20	40.60	38.00	500	MDF240233R	2X33	66.60	64.00	300
MDF24028R	2X8	16.60	14.00	1000	MDF240221R	2X21	42.60	40.00	300	MDF240234R	2X34	68.60	66.00	300
MDF24029R	2X9	18.60	16.00	1000	MDF240222R	2X22	44.60	42.00	300	MDF240235R	2X35	70.60	68.00	300
MDF24030R	2X10	20.60	18.00	1000	MDF240223R	2X23	46.60	44.00	300	MDF240236R	2X36	72.60	70.00	300
MDF24031R	2X11	22.60	20.00	500	MDF240224R	2X24	48.60	46.00	300	MDF240237R	2X37	74.60	72.00	300
MDF24032R	2X12	24.60	22.00	500	MDF240225R	2X25	50.60	48.00	300	MDF240238R	2X38	76.60	74.00	300
MDF24033R	2X13	26.60	24.00	500	MDF240226R	2X26	52.60	50.00	300	MDF240239R	2X39	78.60	76.00	300
MDF24034R	2X14	28.60	26.00	500	MDF240227R	2X27	54.60	52.00	300	MDF240240R	2X40	80.60	78.00	300

# 2402 Wire to Board Connectors



## CONNECTOR - Top Entry

Part No.: M24022~M240240

產品編號

Material: Housing: P.B.T 94V-2, Black

材質

塑膠座

黑色

Contact Pin : Brass, Gold-flash

接觸針

黃銅, 鍍金

Suitable Contact: : 2402PS-2 2402PS-00

配合端子

Suitable Housing: P24022~P240240

配合塑膠

Applicable Wire: AWG# 26~30

適用電線

Square Contact Pin : 0.50±0.02mm

方型接觸針

## PERFORMANCE

Electrical Rating: AC/DC 250V 1A

額定電壓電流

Insulation Resistance: 500MΩ min.

絕緣阻抗

Withstanding Voltage: 500V AC/minute

耐電壓

Temperature Range: -40°C~+105°C

適用溫度



2.0mm

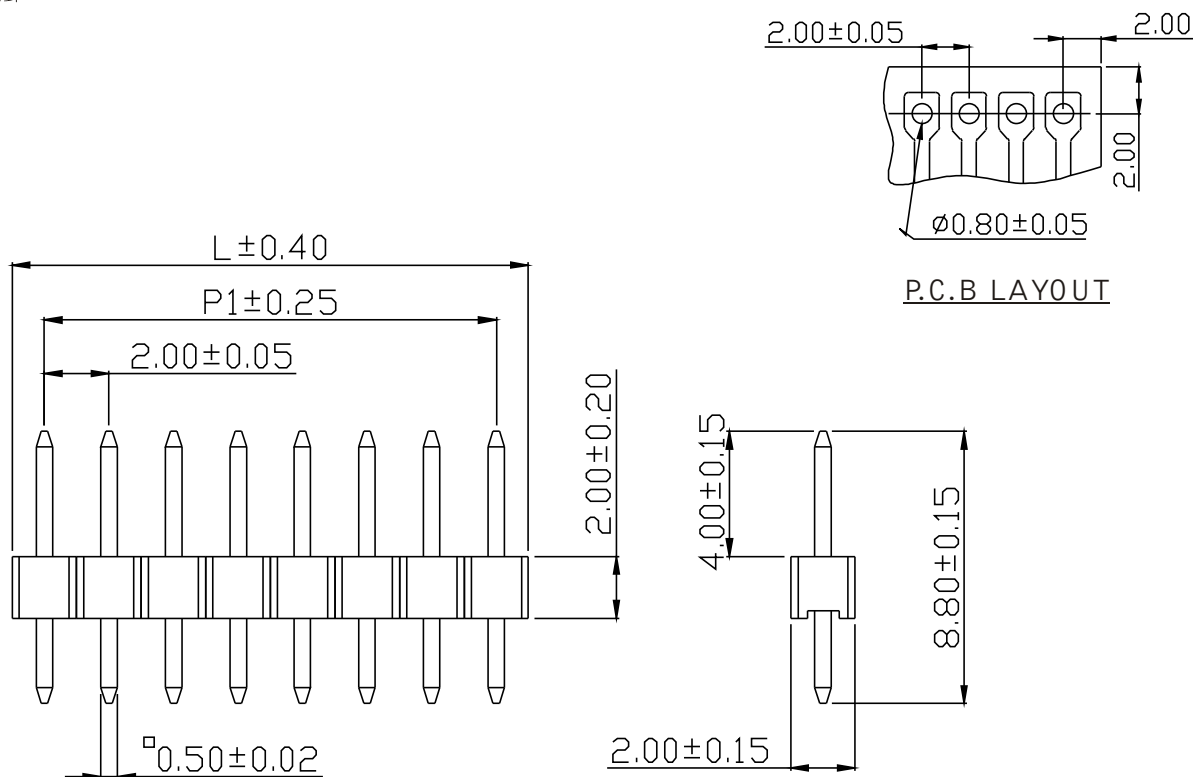

Unit: mm

Part No.	POS.	L	P1	Pack.	Part No.	POS.	L	P1	Pack.	Part No.	POS.	L	P1	Pack.
M24022	2	4.00	2.00	1000	M240215	15	30.00	28.00	1000	M240228	28	56.00	54.00	500
M24023	3	6.00	4.00	1000	M240216	16	32.00	30.00	1000	M240229	29	58.00	56.00	500
M24024	4	8.00	6.00	1000	M240217	17	34.00	32.00	1000	M240230	30	60.00	58.00	500
M24025	5	10.00	8.00	1000	M240218	18	36.00	34.00	1000	M240231	31	62.00	60.00	500
M24026	6	12.00	10.00	1000	M240219	19	38.00	36.00	1000	M240232	32	64.00	62.00	500
M24027	7	14.00	12.00	1000	M240220	20	40.00	38.00	1000	M240233	33	66.00	64.00	200
M24028	8	16.00	14.00	1000	M240221	21	42.00	40.00	1000	M240234	34	68.00	66.00	200
M24029	9	18.00	16.00	1000	M240222	22	44.00	42.00	1000	M240235	35	70.00	68.00	200
M240210	10	20.00	18.00	1000	M240223	23	46.00	44.00	1000	M240236	36	72.00	70.00	200
M240211	11	22.00	20.00	1000	M240224	24	48.00	46.00	1000	M240237	37	74.00	72.00	200
M240212	12	24.00	22.00	1000	M240225	25	50.00	48.00	1000	M240238	38	76.00	74.00	200
M240213	13	26.00	24.00	1000	M240226	26	52.00	50.00	500	M240239	39	78.00	76.00	200
M240214	14	28.00	26.00	1000	M240227	27	54.00	52.00	500	M240240	40	80.00	78.00	200



# 2402 Wire to Board Connectors



## CONNECTOR - Top Entry

Part No.: MD24022~MD240240

產品編號

Material: Housing: P.B.T 94V-2, Black

材質 塑膠座 黑色

Contact Pin : Brass, Gold-flash

接觸針 黃銅, 鍍金

Suitable Contact: : 2402PS-2 2402PS-00

配合端子

Suitable Housing: PD24021~PD240240

配合塑膠

MDF24022~MDF240240

Applicable Wire: AWG# 26~30

適用電線

Square Contact Pin :  $0.50 \pm 0.02$ mm

方型接觸針

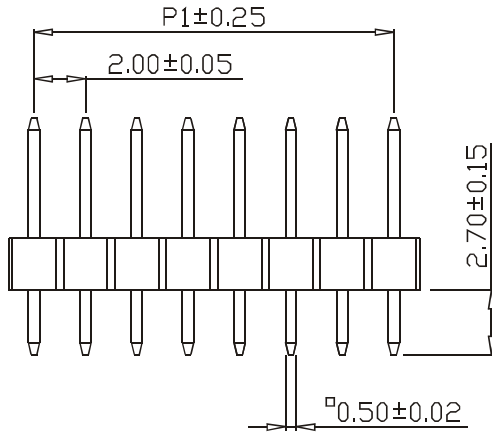
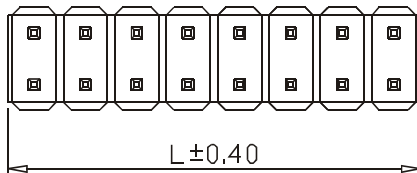

## PERFORMANCE

Electrical Rating: AC/DC 250V 1A

額定電壓電流

Insulation Resistance: 500MΩ min.

絕緣阻抗

Withstanding Voltage: 500V AC/minute

耐電壓

Temperature Range:  $-40^{\circ}\text{C} \sim +105^{\circ}\text{C}$

適用溫度

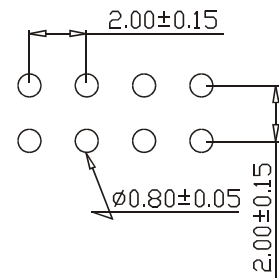

P.C.B LAYOUT

2.0mm

Unit: mm

Part No.	POS.	L	P1	Pack.	Part No.	POS.	L	P1	Pack.	Part No.	POS.	L	P1	Pack.
MD24022	2X2	4.00	2.00	1000	MD240215	2X15	30.00	28.00	500	MD240228	2X28	56.00	54.00	300
MD24023	2X3	6.00	4.00	1000	MD240216	2X16	32.00	30.00	500	MD240229	2X29	58.00	56.00	300
MD24024	2X4	8.00	6.00	1000	MD240217	2X17	34.00	32.00	500	MD240230	2X30	60.00	58.00	300
MD24025	2X5	10.00	8.00	1000	MD240218	2X18	36.00	34.00	500	MD240231	2X31	62.00	60.00	300
MD24026	2X6	12.00	10.00	1000	MD240219	2X19	38.00	36.00	500	MD240232	2X32	64.00	62.00	300
MD24027	2X7	14.00	12.00	1000	MD240220	2X20	40.00	38.00	500	MD240233	2X33	66.00	64.00	300
MD24028	2X8	16.00	14.00	1000	MD240221	2X21	42.00	40.00	300	MD240234	2X34	68.00	66.00	300
MD24029	2X9	18.00	16.00	1000	MD240222	2X22	44.00	42.00	300	MD240235	2X35	70.00	68.00	300
MD240210	2X10	20.00	18.00	1000	MD240223	2X23	46.00	44.00	300	MD240236	2X36	72.00	70.00	300
MD240211	2X11	22.00	20.00	500	MD240224	2X24	48.00	46.00	300	MD240237	2X37	74.00	72.00	300
MD240212	2X12	24.00	22.00	500	MD240225	2X25	50.00	48.00	300	MD240238	2X38	76.00	74.00	300
MD240213	2X13	26.00	24.00	500	MD240226	2X26	52.00	50.00	300	MD240239	2X39	78.00	76.00	300
MD240214	2X14	28.00	26.00	500	MD240227	2X27	54.00	52.00	300	MD240240	2X40	80.00	78.00	300

# 2402 Wire to Board Connectors



## CONNECTOR - Side Entry

Part No.: M24022R~M240240R

產品編號

Material: Housing: P.B.T 94V-2, Black

材質 塑膠座 黑色

Contact Pin : Brass, Gold-flash

接觸針 黃銅, 鍍金

Suitable Contact: : 2402PS-2 2402PS-00

配合端子

Suitable Housing: P24022~P240240

配合塑膠

Applicable Wire: AWG# 26~30

適用電線

Square Contact Pin : 0.50±0.02mm

方型接觸針

## PERFORMANCE

Electrical Rating: AC/DC 250V 1A

額定電壓電流

Insulation Resistance: 500MΩ min.

絕緣阻抗

Withstanding Voltage: 500V AC/minute

耐電壓

Temperature Range: -40°C~+105°C

適用溫度



2.0mm

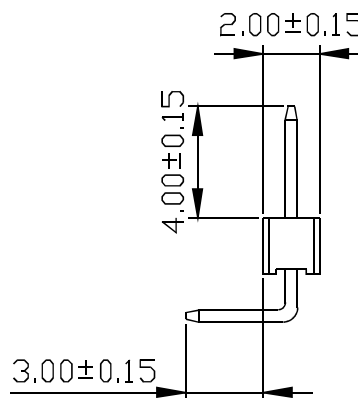
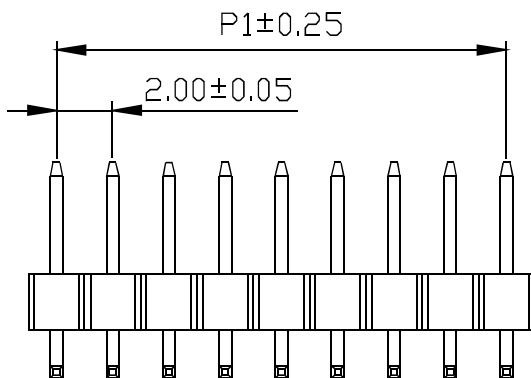
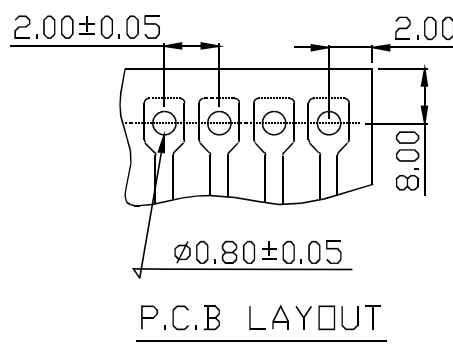
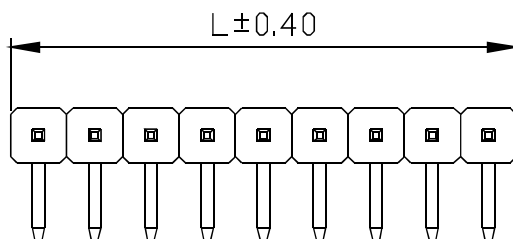

Unit: mm

Part No.	POS.	L	P1	Pack.	Part No.	POS.	L	P1	Pack.	Part No.	POS.	L	P1	Pack.
M24022R	2	4.00	2.00	1000	M240215R	15	30.00	28.00	1000	M240228R	28	56.00	54.00	500
M24023R	3	6.00	4.00	1000	M240216R	16	32.00	30.00	1000	M240229R	29	58.00	56.00	500
M24024R	4	8.00	6.00	1000	M240217R	17	34.00	32.00	1000	M240230R	30	60.00	58.00	500
M24025R	5	10.00	8.00	1000	M240218R	18	36.00	34.00	1000	M240231R	31	62.00	60.00	500
M24026R	6	12.00	10.00	1000	M240219R	19	38.00	36.00	1000	M240232R	32	64.00	62.00	500
M24027R	7	14.00	12.00	1000	M240220R	20	40.00	38.00	1000	M240233R	33	66.00	64.00	200
M24028R	8	16.00	14.00	1000	M240221R	21	42.00	40.00	1000	M240234R	34	68.00	66.00	200
M24029R	9	18.00	16.00	1000	M240222R	22	44.00	42.00	1000	M240235R	35	70.00	68.00	200
M240210R	10	20.00	18.00	1000	M240223R	23	46.00	44.00	1000	M240236R	36	72.00	70.00	200
M240211R	11	22.00	20.00	1000	M240224R	24	48.00	46.00	1000	M240237R	37	74.00	72.00	200
M240212R	12	24.00	22.00	1000	M240225R	25	50.00	48.00	1000	M240238R	38	76.00	74.00	200
M240213R	13	26.00	24.00	1000	M240226R	26	52.00	50.00	500	M240239R	39	78.00	76.00	200
M240214R	14	28.00	26.00	1000	M240227R	27	54.00	52.00	500	M240240R	40	80.00	78.00	200

# 2402 Wire to Board Connectors



## CONNECTOR - Side Entry

Part No.: MD24021R~MD240240R

產品編號

Material: Housing: P.B.T 94V-2, Black

材質

塑膠座

黑色

Contact Pin : Brass, Gold-flash

接觸針

黃銅,

鍍金

Suitable Contact: : 2402PS-2 2402PS-00

配合端子

Suitable Housing: PD24021~PD240240

配合塑膠

MDF24022R~MDF240240R

Applicable Wire: AWG# 26~30

適用電線

Square Contact Pin : 0.50±0.02mm

方型接觸針

## PERFORMANCE

Electrical Rating: AC/DC 250V 1A

額定電壓電流

Insulation Resistance: 500MΩ min.

絕緣阻抗

Withstanding Voltage: 500V AC/minute

耐電壓

Temperature Range: -40°C~+105°C

適用溫度

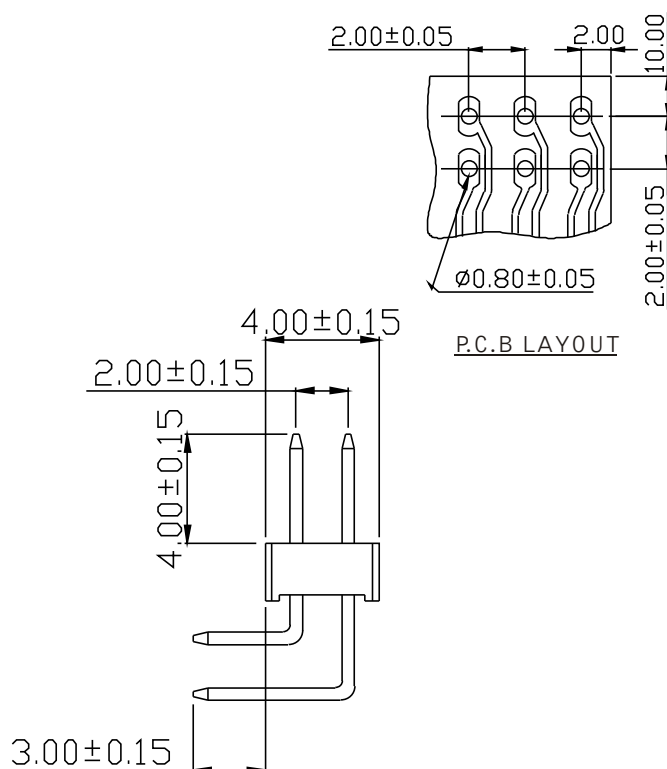
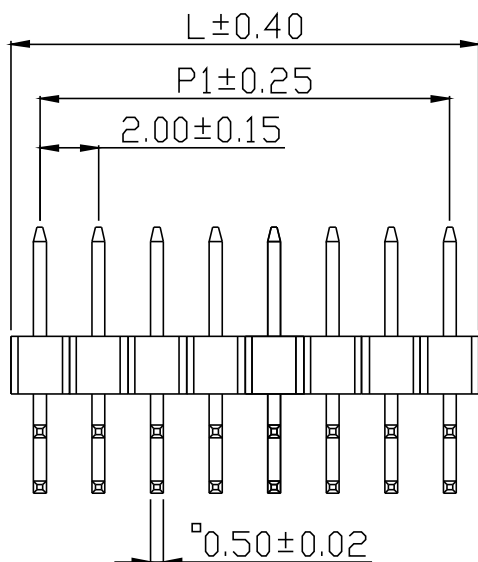

2.0mm

Unit: mm

Part No.	POS.	L	P1	Pack.	Part No.	POS.	L	P1	Pack.	Part No.	POS.	L	P1	Pack.
MD24022R	2X2	4.00	2.00	1000	MD240215R	2X15	30.00	28.00	500	MD240228R	2X28	56.00	54.00	300
MD24023R	2X3	6.00	4.00	1000	MD240216R	2X16	32.00	30.00	500	MD240229R	2X29	58.00	56.00	300
MD24024R	2X4	8.00	6.00	1000	MD240217R	2X17	34.00	32.00	500	MD240230R	2X30	60.00	58.00	300
MD24025R	2X5	10.00	8.00	1000	MD240218R	2X18	36.00	34.00	500	MD240231R	2X31	62.00	60.00	300
MD24026R	2X6	12.00	10.00	1000	MD240219R	2X19	38.00	36.00	500	MD240232R	2X32	64.00	62.00	300
MD24027R	2X7	14.00	12.00	1000	MD240220R	2X20	40.00	38.00	500	MD240233R	2X33	66.00	64.00	300
MD24028R	2X8	16.00	14.00	1000	MD240221R	2X21	42.00	40.00	300	MD240234R	2X34	68.00	66.00	300
MD24029R	2X9	18.00	16.00	1000	MD240222R	2X22	44.00	42.00	300	MD240235R	2X35	70.00	68.00	300
MD240210R	2X10	20.00	18.00	1000	MD240223R	2X23	46.00	44.00	300	MD240236R	2X36	72.00	70.00	300
MD240211R	2X11	22.00	20.00	500	MD240224R	2X24	48.00	46.00	300	MD240237R	2X37	74.00	72.00	300
MD240212R	2X12	24.00	22.00	500	MD240225R	2X25	50.00	48.00	300	MD240238R	2X38	76.00	74.00	300
MD240213R	2X13	26.00	24.00	500	MD240226R	2X26	52.00	50.00	300	MD240239R	2X39	78.00	76.00	300
MD240214R	2X14	28.00	26.00	500	MD240227R	2X27	54.00	52.00	300	MD240240R	2X40	80.00	78.00	300

# 2402 Wire to Board Connectors



## HOUSING

Part No.: P24021~P240240

產品編號

Material: Nylon 94V-2, Black

材質

黑色

Suitable Contact: : 2402PS-2 2402PS-00

配合端子

Suitable Connector: M24022~M240240

配合公座

M24022R~M240240R

MS24022~MS240240

Applicable Wire:AWG# 26~30

適用電線

## PERFORMANCE

Electrical Rating: AC/DC 250V 3A

額定電壓電流

Insulation Resistance: 1000MΩ min.

絕緣阻抗

Withstanding Voltage: 250V AC/minute

耐電壓

Temperature Range: -25°C~+85°C

適用溫度



2.0mm

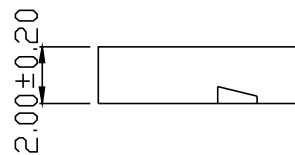
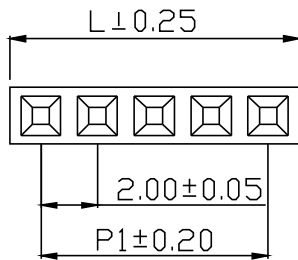

Jumper: Part Number PIN2402

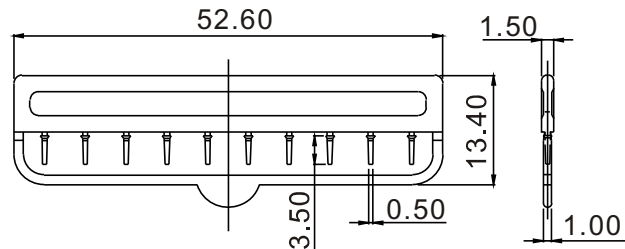
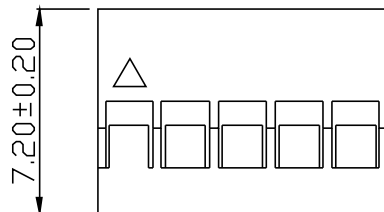

Unit: mm

Part No.	POS.	L	P1	Pack.	Part No.	POS.	L	P1	Pack.	Part No.	POS.	L	P1	Pack.
P24022	2	4.20	2.00	1000	P240215	15	30.20	28.00	500	P240228	28	56.20	54.00	500
P24023	3	6.20	4.00	1000	P240216	16	32.20	30.00	500	P240229	29	58.20	56.00	500
P24024	4	8.20	6.00	1000	P240217	17	34.20	32.00	500	P240230	30	60.20	58.00	500
P24025	5	10.20	8.00	1000	P240218	18	36.20	34.00	500	P240231	31	62.20	60.00	500
P24026	6	12.20	10.00	1000	P240219	19	38.20	36.00	500	P240232	32	64.20	62.00	500
P24027	7	14.20	12.00	1000	P240220	20	40.20	38.00	500	P240233	33	66.20	64.00	500
P24028	8	16.20	14.00	1000	P240221	21	42.20	40.00	500	P240234	34	68.20	66.00	500
P24029	9	18.20	16.00	1000	P240222	22	44.20	42.00	500	P240235	35	70.20	68.00	500
P240210	10	20.20	18.00	1000	P240223	23	46.20	44.00	500	P240236	36	72.20	70.00	500
P240211	11	22.20	20.00	1000	P240224	24	48.20	46.00	500	P240237	37	74.20	72.00	500
P240212	12	24.20	22.00	1000	P240225	25	50.20	48.00	500	P240238	38	76.20	74.00	500
P240213	13	26.20	24.00	1000	P240226	26	52.20	50.00	500	P240239	39	78.20	76.00	500
P240214	14	28.20	26.00	500	P240227	27	54.20	52.00	500	P240240	40	80.20	78.00	500

# 2402 Wire to Board Connectors



## HOUSING

Part No.: PD24021~PD240240

產品編號

Material: Nylon 94V-2, Black

材質

黑色

Suitable Contact: : 2402PS-2 2402PS-00

配合端子

Suitable Connector: MD24021~MD240240

配合公座

MD24021R~MD240240R

MDS24022~MDS240240

MDF24022~MDF240240

MDF24022R~MDF240240R

Applicable Wire: AWG# 26~30

適用電線

## PERFORMANCE

Electrical Rating: AC/DC 250V 3A

額定電壓電流

Insulation Resistance: 1000MΩ min.

絕緣阻抗

Withstanding Voltage: 250V AC/minute

耐電壓

Temperature Range: -25°C~+85°C

適用溫度

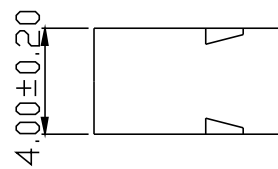
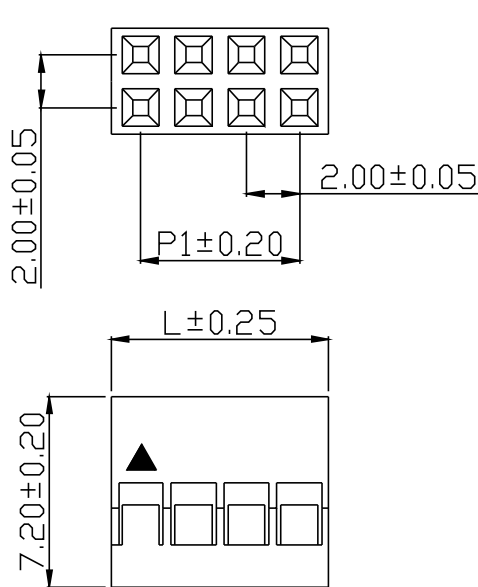

Jumper: Part Number PIN2402

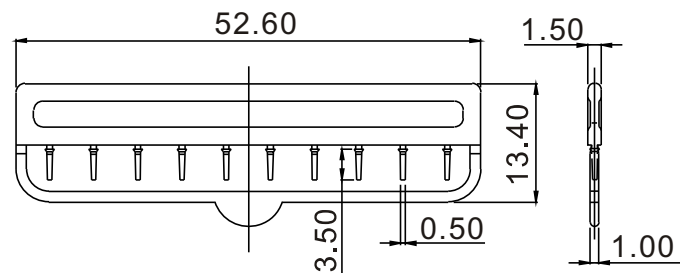

Unit: mm														
Part No.	POS.	L	P1	Pack.	Part No.	POS.	L	P1	Pack.	Part No.	POS.	L	P1	Pack.
PD24022	2X2	4.20	2.00	1000	PD240215	2X15	30.20	28.00	1000	PD240228	2X28	56.20	54.00	500
PD24023	2X3	6.20	4.00	1000	PD240216	2X16	32.20	30.00	1000	PD240229	2X29	58.20	56.00	500
PD24024	2X4	8.20	6.00	1000	PD240217	2X17	34.20	32.00	500	PD240230	2X30	60.20	58.00	500
PD24025	2X5	10.20	8.00	1000	PD240218	2X18	36.20	34.00	500	PD240231	2X31	62.20	60.00	250
PD24026	2X6	12.20	10.00	1000	PD240219	2X19	38.20	36.00	500	PD240232	2X32	64.20	62.00	250
PD24027	2X7	14.20	12.00	1000	PD240220	2X20	40.20	38.00	500	PD240233	2X33	66.20	64.00	250
PD24028	2X8	16.20	14.00	1000	PD240221	2X21	42.20	40.00	500	PD240234	2X34	68.20	66.00	250
PD24029	2X9	18.20	16.00	1000	PD240222	2X22	44.20	42.00	500	PD240235	2X35	70.20	68.00	250
PD240210	2X10	20.20	18.00	1000	PD240223	2X23	46.20	44.00	500	PD240236	2X36	72.20	70.00	250
PD240211	2X11	22.20	20.00	1000	PD240224	2X24	48.20	46.00	500	PD240237	2X37	74.20	72.00	250
PD240212	2X12	24.20	22.00	1000	PD240225	2X25	50.20	48.00	500	PD240238	2X38	76.20	74.00	250
PD240213	2X13	26.20	24.00	1000	PD240226	2X26	52.20	50.00	500	PD240239	2X39	78.20	76.00	250
PD240214	2X14	28.20	26.00	1000	PD240227	2X27	54.20	52.00	500	PD240240	2X40	80.20	78.00	250

2.0mm

# 2402 Wire to Board Connectors



## TERMINAL

Part No.: 2402PS-2 2402PS-00

產品編號

Thickness: 0.20mm

銅板厚度

Material: Phosphor Bronze

材質 磷青銅

Surface Treatment: Tin-plated (-2)

表面處理

鍍錫

Gold-flash(-00)A

鍍金

Applicable Wire: AWG#26-30

適用電線

Insulation O.D.: 0.80~1.20mm

線皮外徑

Suitable Housing: P24021~P240240 PD24021~PD240240

配合塑膠

Suitable Connector: M24022~M240240 MD24021~MD240240

配合公座

M24022R~M240240R MD24021R~MD240240R

MS24022~MS240240 MDS24021~MDS240240

MDF24022~MDF240240 MDF24022R~MDF240240R

Packing: 10,000PCS(Reel)

包裝數量

## PERFORMANCE

Electrical Rating: AC/DC 250V 3A

額定電壓電流

Insulation Resistance: 1000MΩ min.

絕緣阻抗

Withstanding Voltage: 250V AC/minute

耐電壓

Temperature Range: -25°C~+85°C

適用溫度



2.0mm

