

# 24027

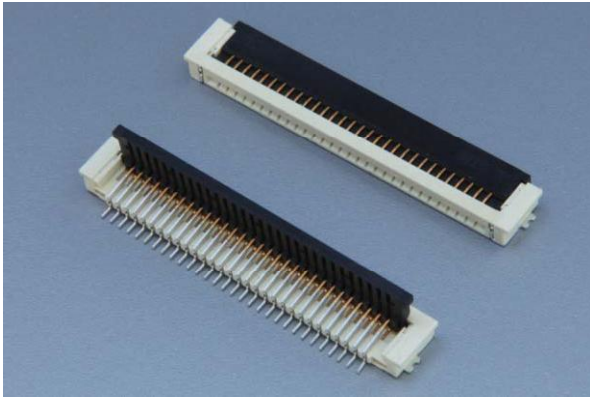

## Pitch 1.0mm FPC Connectors - SMT Type



### PERFORMANCE

Electrical Rating: AC/DC 50V 1A

額定電壓電流

Insulation Resistance: 500MΩ min.

絕緣阻抗

Withstanding Voltage: 500V AC/minute

耐電壓

Temperature Range: -40°C~+85°C

適用溫度



1.0mm

### CONNECTOR - On Board Type

Part No.: MS24027P30

產品編號

Material: Housing: LCP 94V-0

材質 塑膠座

Contact Pin: Brass

接觸針 黃銅

Clamshell: Nylon 94V-0, Black

旋轉蓋 黑色

Reinforcement: Brass

補強片 黃銅

Applicable Wire: FPC: 0.3mm thick flat cable

適用電線

Packing: 1,500pcs/reel

包裝數量

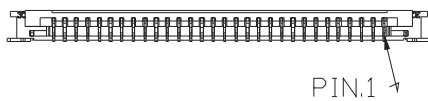
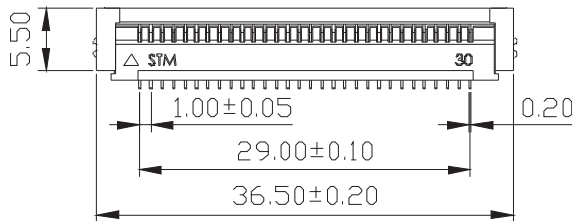
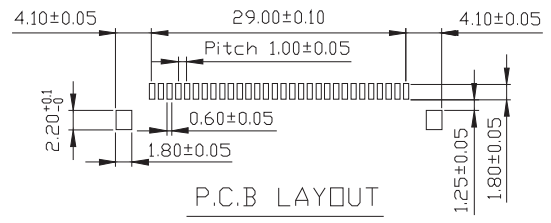

PIN.1

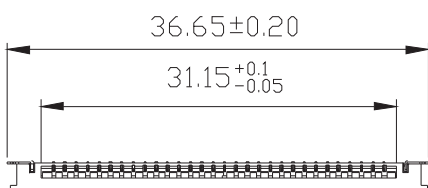
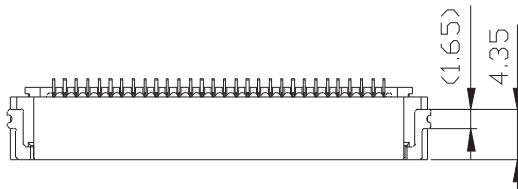
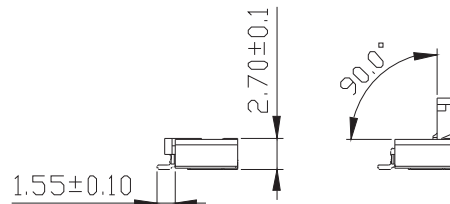

TOLERANCE	
.0	±0.25
.00	±0.15
.000	±0.05

Behave in conformity with continual product development policy, Sin Sheng (STM) reserves the right of specification changing of contents described in this catalogue at any time and without prior notice. Please contact the sales department nearby for most updated information.  
由於產品持續開發的政策, 信盛(STM)保留隨時變更本目錄所述之規格且不需提前通知的權利, 請逕繫業務處查詢最新的產品資訊。

# 24027 FFC/FPC Connectors - SMT Type

## CONNECTOR - On Board Type

Part No.: **MS24027P30 RF:C**

產品編號

Material: **Housing: LCP 94V-0**

材質

塑膠座

Contact Pin: **Brass**

接觸針

黃銅

Clamshell: **Nylon 94V-0, Black**

旋轉蓋

黑色

Reinforcement: **Brass**

補強片

黃銅

Applicable Wire: **FPC: 0.3mm thick flat cable**

適用電線

Packing: **1,500pcs/reel**

包裝數量

## PERFORMANCE

Electrical Rating: **AC/DC 50V 1A**

額定電壓電流

Insulation Resistance: **500MΩ min.**

絕緣阻抗

Withstanding Voltage: **500V AC/minute**

耐電壓

Temperature Range: **-40°C~+85°C**

適用溫度

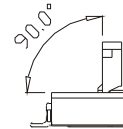
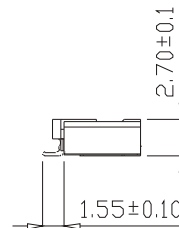
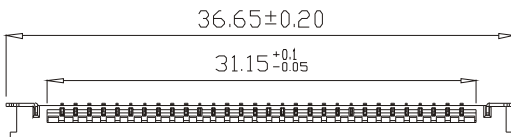
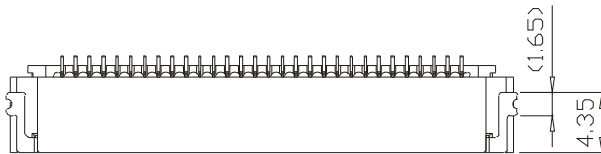
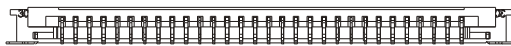
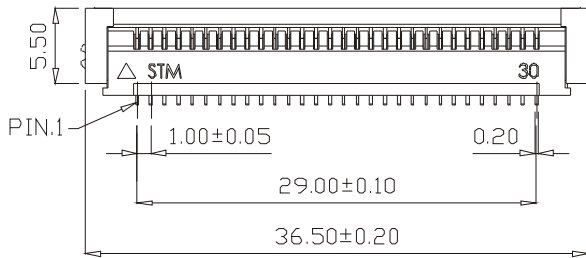
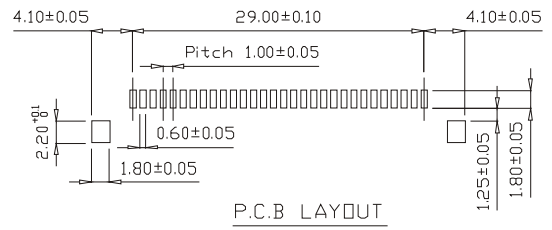

1.0mm

# 24027 FFC/FPC Connectors - SMT Type

## CONNECTOR - On Board Type

Part No.: **MS24027P30 RF:D**

產品編號

Material: **Housing: LCP 94V-0**

材質

塑膠座

Contact Pin: **Brass**

接觸針

黃銅

Clamshell: **Nylon 94V-0, Black**

旋轉蓋

黑色

Reinforcement: **Brass**

補強片

黃銅

Applicable Wire: **FPC: 0.3mm thick flat cable**

適用電線

Packing: **1,500pcs/reel**

包裝數量

## PERFORMANCE

Electrical Rating: **AC/DC 50V 1A**

額定電壓電流

Insulation Resistance: **500MΩ min.**

絕緣阻抗

Withstanding Voltage: **500V AC/minute**

耐電壓

Temperature Range: **-25°C~+85°C**

適用溫度

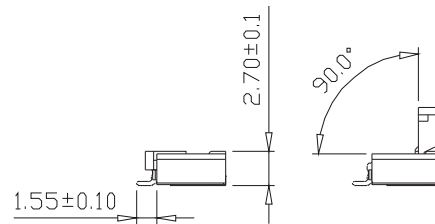
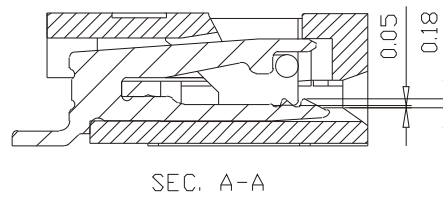
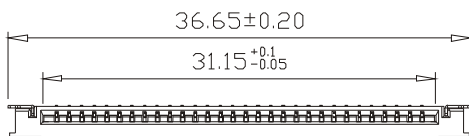
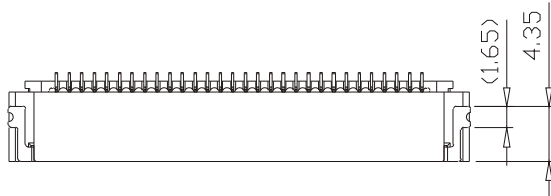
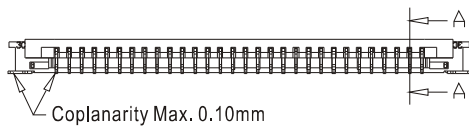
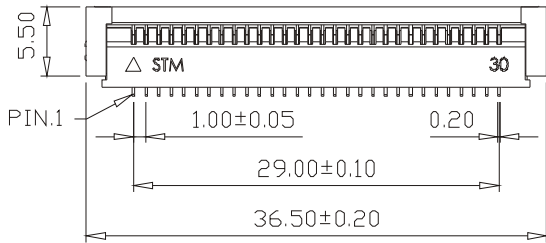
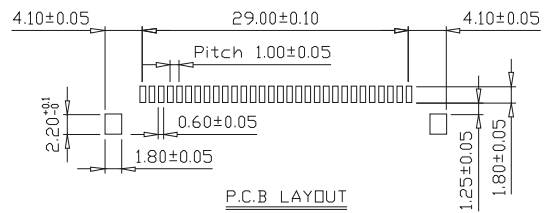

1.0mm

# 24027 FFC/FPC Connectors - SMT Type

## CONNECTOR - On Board Type

Part No.: **MS24027P30 RF:E**

產品編號

Material: **Housing: LCP 94V-0**

材質

塑膠座

Contact Pin: **Brass**

接觸針

黃銅

Clamshell: **Nylon 94V-0, Black**

旋轉蓋

黑色

Reinforcement: **Brass**

補強片

黃銅

Applicable Wire: **FPC: 0.3mm thick flat cable**

適用電線

Packing: **1,500pcs/reel**

包裝數量

## PERFORMANCE

Electrical Rating: **AC/DC 50V 1A**

額定電壓電流

Insulation Resistance: **500MΩ min.**

絕緣阻抗

Withstanding Voltage: **500V AC/minute**

耐電壓

Temperature Range: **-40°C~+85°C**

適用溫度

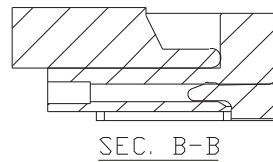
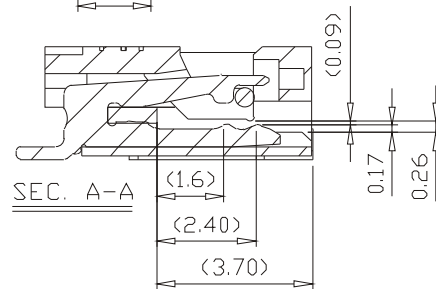
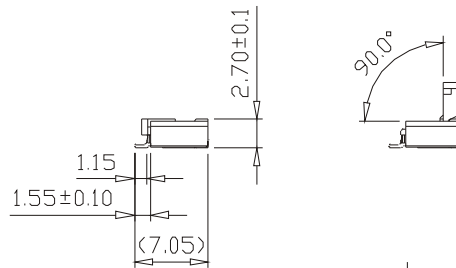
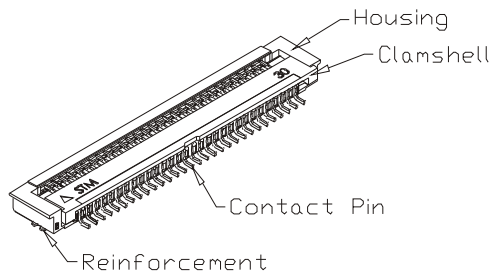
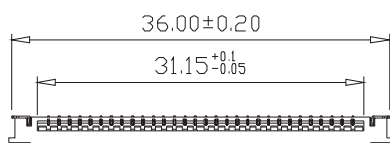
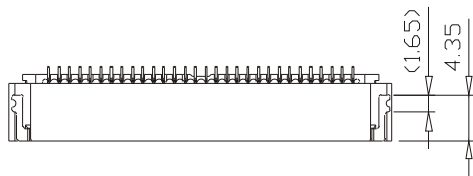
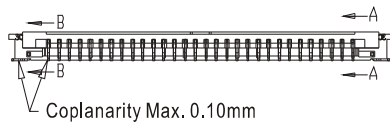
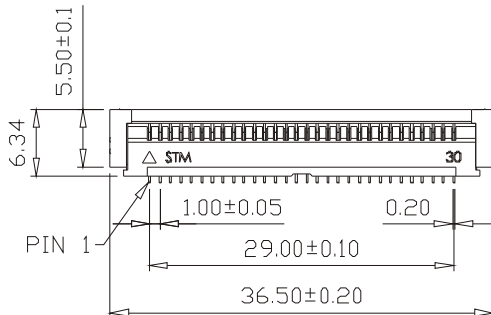
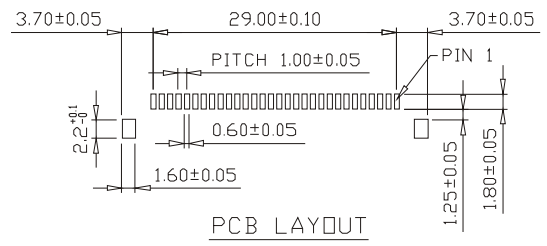

1.0mm

# 24027

## FFC/FPC Connectors - SMT Type

### Embossed Carrier Tape Dimensional Drawing

MS24027P30 Series

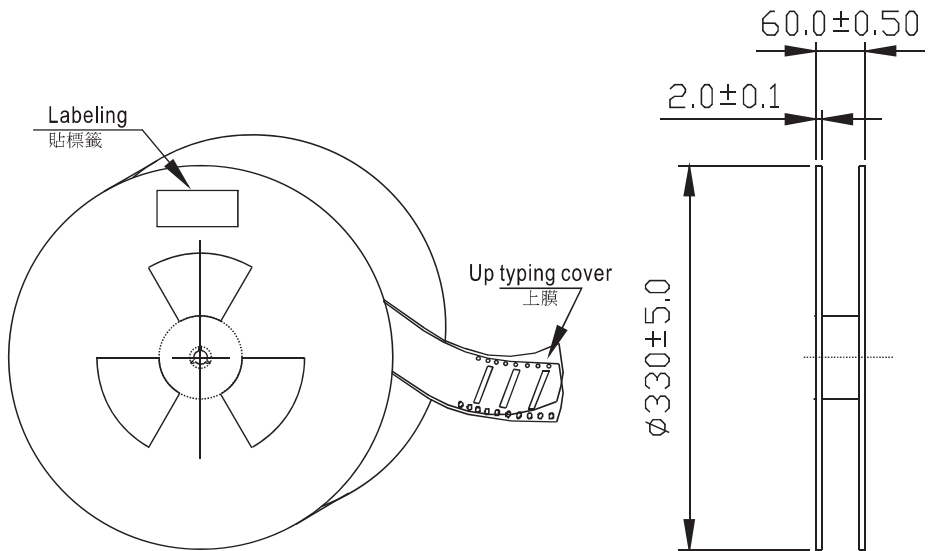
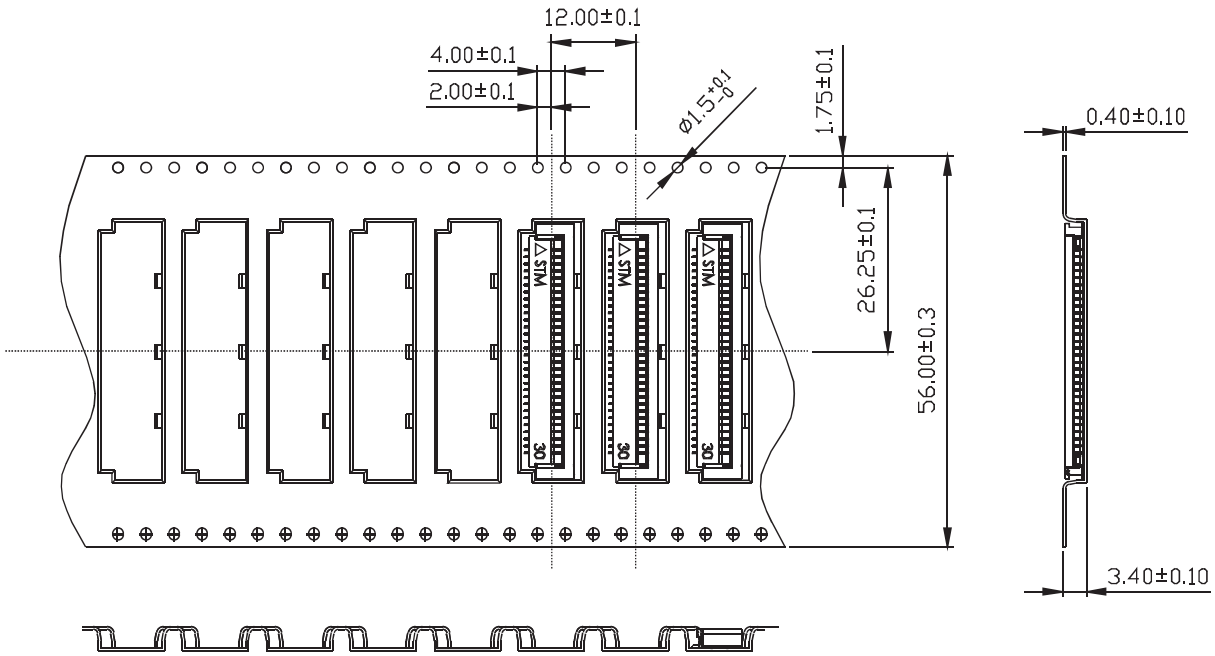

Onward direction of finished product  
成品出料方向

1.0mm