

2411

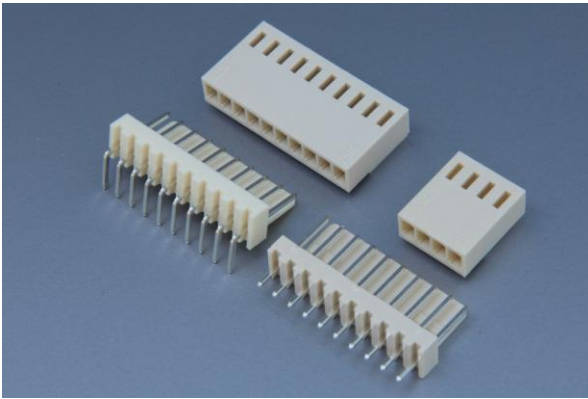

Pitch 2.54mm Wire to Board Connectors



PERFORMANCE

Electrical Rating: AC/DC 250V 5A
 額定電壓電流
 Insulation Resistance: 1000MΩ min.
 絕緣阻抗
 Withstanding Voltage: 1000V AC/minute
 耐電壓
 Temperature Range: -25°C~+85°C
 適用溫度



CONNECTOR - Top Entry

Part No.: M24112~M241120

產品編號

Material: Housing: Nylon 94V-2

材質 塑膠座

Contact Pin: Brass, Tin-plated

接觸針 黃銅, 鍍錫

Suitable Contact: 24111BS-2 24111PS-2

配合端子

Suitable Housing: P24112~P241120

配合塑膠

Applicable Wire: AWG# 20~26

適用電線

Square Contact Pin: 0.64±0.02mm

方型接觸針

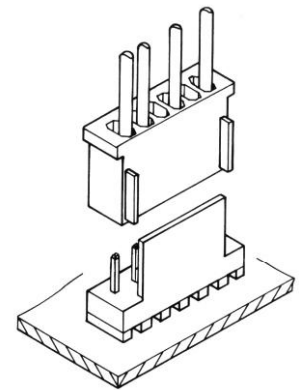

2.54mm

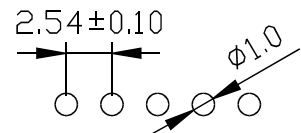
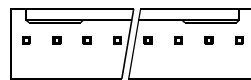

P.C.B LAYOUT

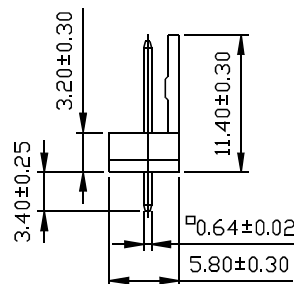
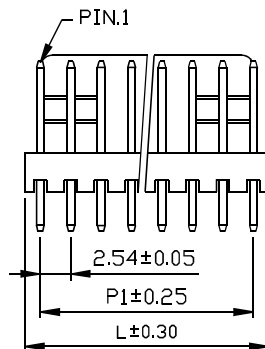

Unit: mm

Part No.	POS.	L	P1	Pack.	Part No.	POS.	L	P1	Pack.
M24112	2	5.12	2.54	1000	M241112	12	30.68	27.94	500
M24113	3	7.66	5.08	1000	M241113	13	33.10	30.48	500
M24114	4	10.20	7.62	1000	M241114	14	35.80	33.02	500
M24115	5	12.74	10.16	1000	M241115	15	38.34	35.56	250
M24116	6	15.30	12.70	1000	M241116	16	40.94	38.10	250
M24117	7	17.94	15.24	1000	M241117	17	43.30	40.64	250
M24118	8	20.48	17.78	500	M241118	18	45.90	43.18	250
M24119	9	23.02	20.32	500	M241119	19	48.56	45.72	250
M241110	10	25.58	22.86	500	M241120	20	50.80	48.26	500
M241111	11	28.12	25.40	500					

Behave in conformity with continual product development policy, SinSheng (STM) reserves the right of specification changing of contents described in this catalogue at any time and without prior notice. Please contact the sales department nearby for most updated information.
 由於產品持續開發的政策, 信盛(STM)保留隨時變更本目錄所述之規格且不需提前通知的權利。請連繫業務處查詢最新的產品資訊。

2411 Wire to Board Connectors



CONNECTOR - Side Entry

Part No.: M24112R~M241120R

產品編號

Material: Housing: Nylon 94V-2

材質

塑膠座

Contact Pin: Brass, Tin-plated

接觸針

黃銅

鍍錫

Suitable Contact: 24111BS-2 24111PS-2

配合端子

Suitable Housing: P24112~P241120

配合塑膠

Applicable Wire: AWG# 20~26

適用電線

Square Contact Pin: 0.64±0.02mm

方型接觸針

PERFORMANCE

Electrical Rating: AC/DC 250V 5A

額定電壓電流

Insulation Resistance: 1000MΩ min.

絕緣阻抗

Withstanding Voltage: 1000V AC/minute

耐電壓

Temperature Range: -25°C~+85°C

適用溫度

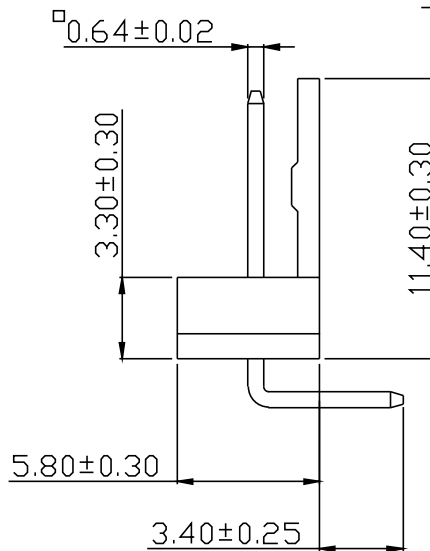
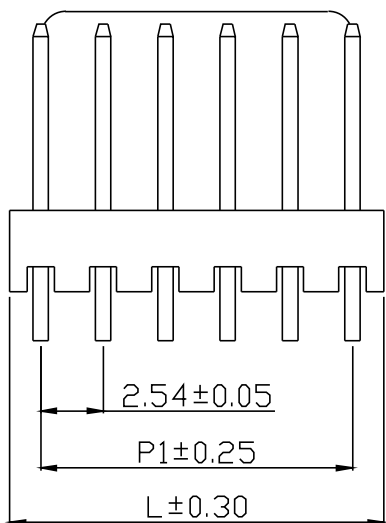
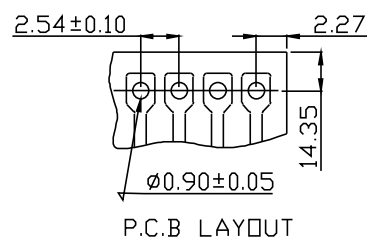

2.54mm

Unit: mm

Part No.	POS.	L	P1	Pack.	Part No.	POS.	L	P1	Pack.
M24112R	2	5.08	2.54	1000	M241112R	12	30.48	27.94	500
M24113R	3	7.62	5.08	1000	M241113R	13	33.02	30.48	500
M24114R	4	10.16	7.62	1000	M241114R	14	35.56	33.02	500
M24115R	5	12.70	10.16	1000	M241115R	15	38.10	35.56	500
M24116	6	15.24	12.70	1000	M241116R	16	40.64	38.10	500
M24117R	7	17.78	15.24	1000	M241117R	17	43.18	40.64	500
M24118R	8	20.32	17.78	1000	M241118R	18	45.72	43.18	500
M24119R	9	22.86	20.32	1000	M241119R	19	48.26	45.72	500
M241110R	10	25.40	22.86	1000	M241120R	20	50.80	48.26	500
M241111R	11	27.94	25.40	500					

2411 Wire to Board Connectors



HOUSING

Part No.: P24112~P241120

產品編號

Material: Nylon 94V-0

材質

Suitable Contact: 24111BS-2 24111PS-2

配合端子

Suitable Connector: M24112~M241120

配合公座

M24112R~M241120R

Applicable Wire: AWG# 20~26

適用電線

PERFORMANCE

Electrical Rating: AC/DC 250V 5A

額定電壓電流

Insulation Resistance: 1000MΩ min.

絕緣阻抗

Withstanding Voltage: 1000V AC/minute

耐電壓

Temperature Range: -25°C~+85°C

適用溫度

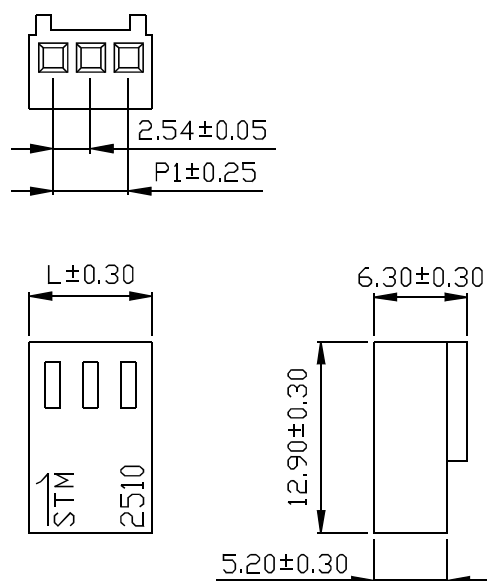

P24112~P24113

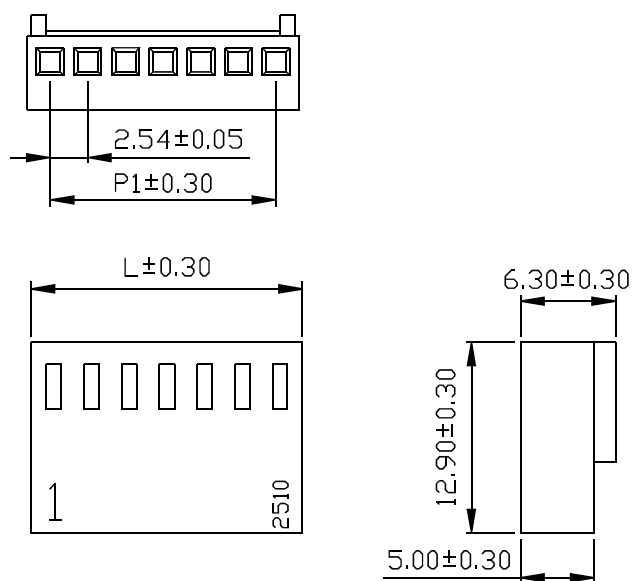

P24114~P241120
P24112~P241120 RF:A

2.54mm

Unit: mm

Part No.	RF	POS	L	P1	Pack.
P24112	A	2	5.64	2.54	1000
P24113	A	3	8.16	5.08	1000

Unit: mm

Part No.	POS.	L	P1	Pack.	Part No.	POS.	L	P1	Pack.
P24112	2	5.74	2.54	1000	P241112	12	31.14	27.94	500
P24113	3	8.28	5.08	1000	P241113	13	33.68	30.48	500
P24114	4	10.82	7.62	1000	P241114	14	36.22	33.02	500
P24115	5	13.36	10.16	1000	P241115	15	38.76	35.56	500
P24116	6	15.90	12.70	1000	P241116	16	41.30	38.10	500
P24117	7	18.44	15.24	1000	P241117	17	43.84	40.64	500
P24118	8	20.98	17.78	1000	P241118	18	46.38	43.18	500
P24119	9	23.52	20.32	1000	P241119	19	48.92	45.72	500
P241110	10	26.06	22.86	1000	P241120	20	51.46	48.26	500
P241111	11	28.60	25.40	500					

2411 Wire to Board Connectors



TERMINAL

Part No.: 2411BS-2 2411PS-2
 產品編號
Thickness: 0.20mm
 銅板厚度
Material: Brass(BS) Phosphor Bronze(PS)
 材質 黃銅 磷青銅
Surface Treatment: Tin-plated
 表面處理 鍍錫
Applicable Wire: AWG# 20~26
 適用電線
Insulation O.D.: 1.35~1.80mm
 線皮外徑
Suitable Housing: P24112~P241120
 配合塑膠
Suitable Connector: M24112~M241120
 配合公座
M24112R~M241120R

Packing: 10,000PCS(Reel)
 包裝數量

PERFORMANCE

Electrical Rating: AC/DC 250V 5A
 額定電壓電流
Insulation Resistance: 1000MΩ min.
 絕緣阻抗
Withstanding Voltage: 1000V AC/minute
 耐電壓
Temperature Range: -25°C~+85°C
 適用溫度



2.54mm

