

24184

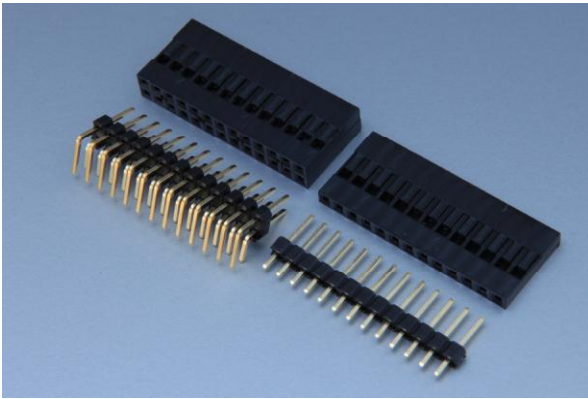

Pitch 2.54mm Wire to Board Connectors - SMT Type



PERFORMANCE

Electrical Rating: AC/DC 250V 3A
 額定電壓電流
 Insulation Resistance: 1000MΩ min.
 絕緣阻抗
 Withstanding Voltage: 1000V AC/minute
 耐電壓
 Temperature Range: -40°C~+105°C
 適用溫度



CONNECTOR - Top Entry

Part No.: MS241842~MS2418440

產品編號

Material: Housing: P.B.T 94V-0, Black

材質 塑膠座 黑色

Contact Pin: Brass, Gold-flash

接觸針 黃銅, 鍍金

Suitable Contact: 24184BS-2 24184BS-00

配合端子

Suitable Housing: P241842~P2418440

配合塑膠

Applicable Wire: AWG# 24~28

適用電線

Square Contact Pin: 0.64±0.02mm

方型接觸針

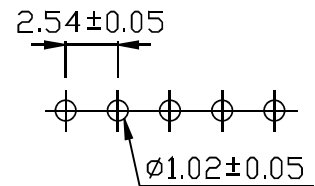
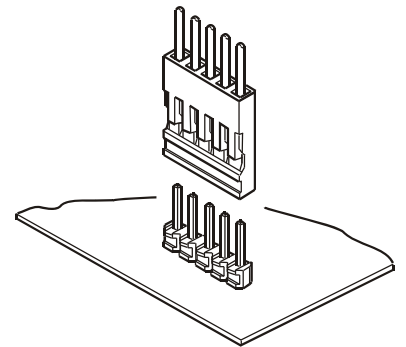

P.C.B LAYOUT

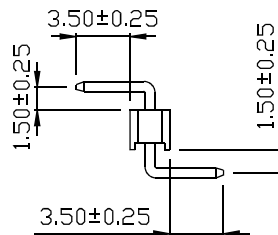
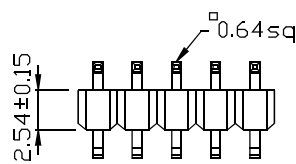
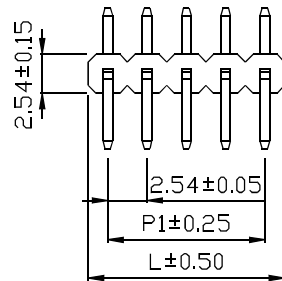

2.54mm

Unit: mm

Part No.	POS.	L	P1	Pack.	Part No.	POS.	L	P1	Pack.	Part No.	POS.	L	P1	Pack.
MS241842	2	5.08	2.54	300	MS2418415	15	38.10	35.56	1000	MS2418428	28	71.12	68.58	500
MS241843	3	7.62	5.08	300	MS2418416	16	40.64	38.10	1000	MS2418429	29	73.66	71.12	500
MS241844	4	10.16	7.62	300	MS2418417	17	43.18	40.64	1000	MS2418430	30	76.20	73.66	500
MS241845	5	12.70	10.16	300	MS2418418	18	45.72	43.18	1000	MS2418431	31	78.74	76.20	500
MS241846	6	15.24	12.70	2000	MS2418419	19	48.26	45.72	1000	MS2418432	32	81.28	78.74	500
MS241847	7	17.78	15.24	2000	MS2418420	20	50.80	48.26	1000	MS2418433	33	83.82	81.28	500
MS241848	8	20.32	17.78	1000	MS2418421	21	53.34	50.80	500	MS2418434	34	86.36	83.82	500
MS241849	9	22.86	20.32	1000	MS2418422	22	55.88	53.34	500	MS2418435	35	88.90	86.36	500
MS2418410	10	25.40	22.86	1000	MS2418423	23	58.42	55.88	500	MS2418436	36	91.44	88.90	500
MS2418411	11	27.94	25.40	1000	MS2418424	24	60.96	58.42	500	MS2418437	37	93.98	91.44	500
MS2418412	12	30.48	27.94	1000	MS2418425	25	63.50	60.96	500	MS2418438	38	96.52	93.98	500
MS2418413	13	33.02	30.48	1000	MS2418426	26	66.04	63.50	500	MS2418439	39	99.06	96.52	500
MS2418414	14	35.56	33.02	1000	MS2418427	27	68.58	66.04	500	MS2418440	40	101.60	99.06	500

Behave in conformity with continual product development policy, SinSheng (STM) reserves the right of specification changing of contents described in this catalogue any time and without prior notice. Please contact the sales department nearby for most updated information.
 由於產品持續開發的政策, 信盛(STM)保留隨時變更本目錄所述之規格且不需提前通知的權利。請連繫業務處查詢最新的產品資訊。

24184 Wire to Board Connectors - SMT Type

CONNECTOR - Top Entry

Part No.: MDS241842~MDS2418440
 產品編號

Material: Housing: P.B.T 94V-0, Black
 材質 塑膠座 黑色

Contact Pin: Brass, Gold-flash
 接觸針 黃銅, 鍍金

Suitable Contact: 24184BS-2 24184BS-00
 配合端子

Suitable Housing: PD241842~PD2418440
 配合塑膠

Applicable Wire: AWG# 24~28
 適用電線

Square Contact Pin: 0.64±0.02mm
 方型接觸針

PERFORMANCE

Electrical Rating: AC/DC 500V 3A
 額定電壓電流

Insulation Resistance: 500MΩ min.
 絕緣阻抗

Withstanding Voltage: 500V AC/minute
 耐電壓

Temperature Range: -40°C~+105°C
 適用溫度

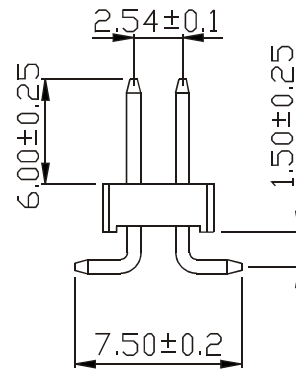
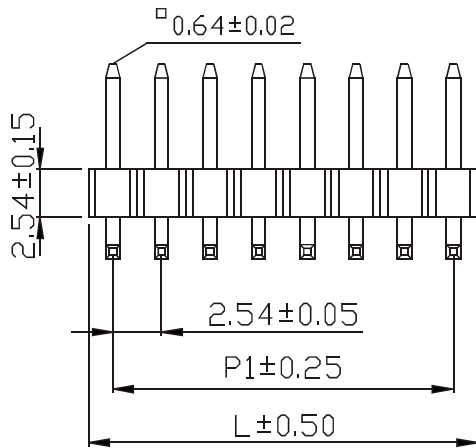
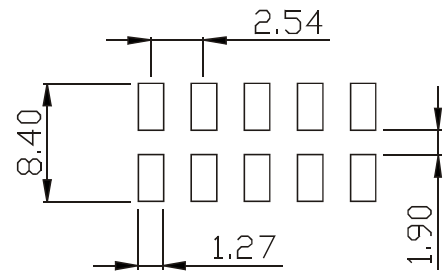
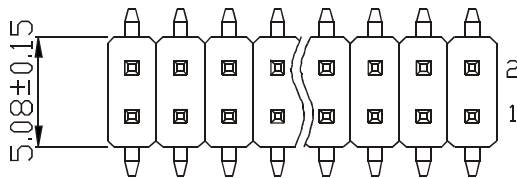

2.54mm

Unit: mm

Part No.	POS.	L	P1	Pack.	Part No.	POS.	L	P1	Pack.	Part No.	POS.	L	P1	Pack.
MDS241842	2X2	5.08	2.54	1000	MDS2418415	2X15	38.10	35.56	1000	MDS2418428	2X28	71.12	68.58	1000
MDS241843	2X3	7.62	5.08	1000	MDS2418416	2X16	40.64	38.10	1000	MDS2418429	2X29	73.66	71.12	1000
MDS241844	2X4	10.16	7.62	1000	MDS2418417	2X17	43.18	40.64	1000	MDS2418430	2X30	76.20	73.66	1000
MDS241845	2X5	12.70	10.16	1000	MDS2418418	2X18	45.72	43.18	1000	MDS2418431	2X31	78.74	76.20	1000
MDS241846	2X6	15.24	12.70	1000	MDS2418419	2X19	48.26	45.72	1000	MDS2418432	2X32	81.28	78.74	1000
MDS241847	2X7	17.78	15.24	1000	MDS2418420	2X20	50.80	48.26	1000	MDS2418433	2X33	83.82	81.28	1000
MDS241848	2X8	20.32	17.78	1000	MDS2418421	2X21	53.34	50.80	1000	MDS2418434	2X34	86.36	83.82	1000
MDS241849	2X9	22.86	20.32	1000	MDS2418422	2X22	55.88	53.34	1000	MDS2418435	2X35	88.90	86.36	1000
MDS2418410	2X10	25.40	22.86	1000	MDS2418423	2X23	58.42	55.88	1000	MDS2418436	2X36	91.44	88.90	1000
MDS2418411	2X11	27.94	25.40	1000	MDS2418424	2X24	60.96	58.42	1000	MDS2418437	2X37	93.98	91.44	1000
MDS2418412	2X12	30.48	27.94	1000	MDS2418425	2X25	63.50	60.96	1000	MDS2418438	2X38	96.52	93.98	1000
MDS2418413	2X13	33.02	30.48	1000	MDS2418426	2X26	66.04	63.50	1000	MDS2418439	2X39	99.06	96.52	1000
MDS2418414	2X14	35.56	33.02	1000	MDS2418427	2X27	68.58	66.04	1000	MDS2418440	2X40	101.60	99.06	1000

CONNECTOR - Top Entry

Part No.: MDS241842~MDS2418440 RF:A

產品編號

Material: Housing: P.B.T 94V-0, Black

材質 塑膠座 黑色

Contact Pin: Brass, Gold-flash

接觸針 黃銅, 鍍金

Suitable Contact: 24184BS-2 24184BS-00

配合端子

Suitable Housing: PD241842~PD2418440

配合塑膠

Applicable Wire: AWG# 24~28

適用電線

Square Contact Pin: 0.64±0.02mm

方型接觸針

PERFORMANCE

Electrical Rating: AC/DC 250V 3A

額定電壓電流

Insulation Resistance: 500MΩ min.

絕緣阻抗

Withstanding Voltage: 500V AC/minute

耐電壓

Temperature Range: -40°C~+105°C

適用溫度

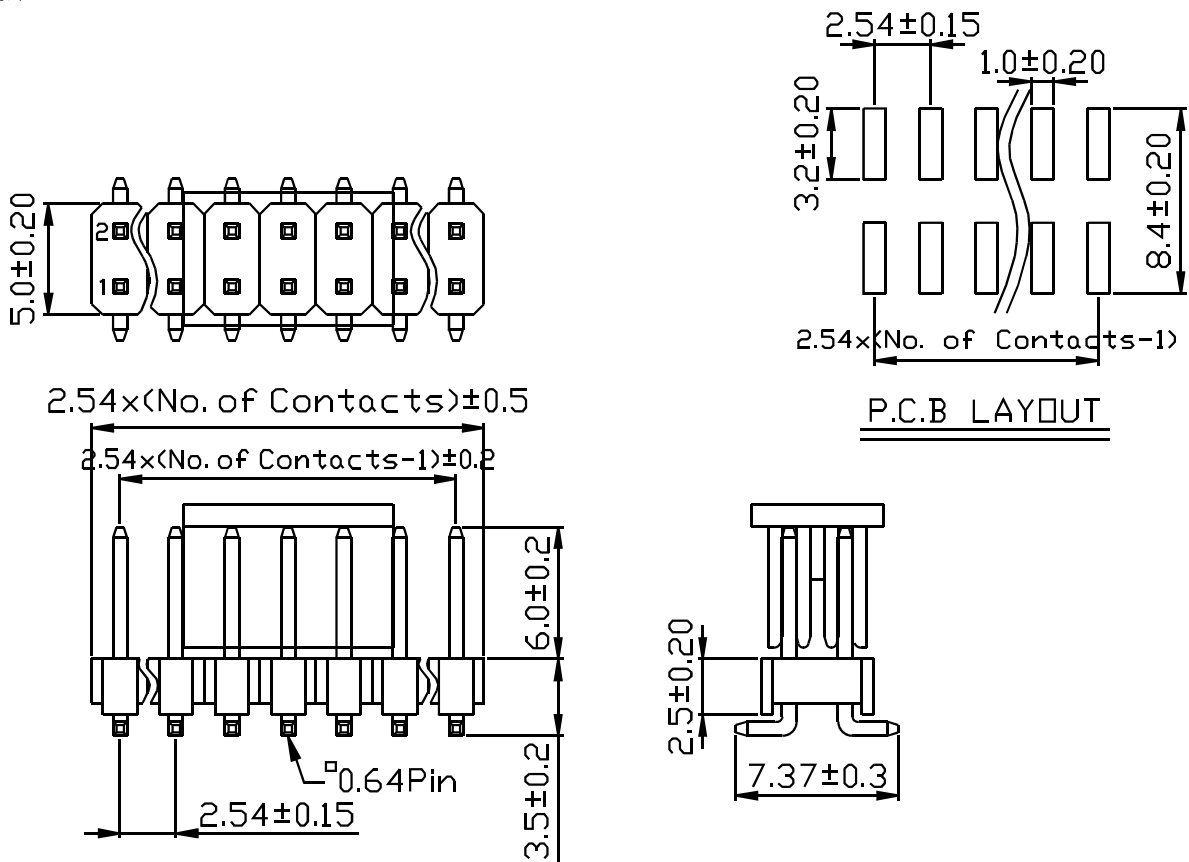

2.54mm

Note: Letters RF:A to be added follows the part number, i.e MDS241842RF:A.

Unit: mm

Part No.	POS.	L	P1	Pack.	Part No.	POS.	L	P1	Pack.	Part No.	POS.	L	P1	Pack.
MDS241842	2X2	5.08	2.54	1000	MDS2418415	2X15	38.10	35.56	1000	MDS2418428	2X28	71.12	68.58	1000
MDS241843	2X3	7.62	5.08	1000	MDS2418416	2X16	40.64	38.10	1000	MDS2418429	2X29	73.66	71.12	1000
MDS241844	2X4	10.16	7.62	1000	MDS2418417	2X17	43.18	40.64	1000	MDS2418430	2X30	76.20	73.66	1000
MDS241845	2X5	12.70	10.16	1000	MDS2418418	2X18	45.72	43.18	1000	MDS2418431	2X31	78.74	76.20	1000
MDS241846	2X6	15.24	12.70	1000	MDS2418419	2X19	48.26	45.72	1000	MDS2418432	2X32	81.28	78.74	1000
MDS241847	2X7	17.78	15.24	1000	MDS2418420	2X20	50.80	48.26	1000	MDS2418433	2X33	83.82	81.28	1000
MDS241848	2X8	20.32	17.78	1000	MDS2418421	2X21	53.34	50.80	1000	MDS2418434	2X34	86.36	83.82	1000
MDS241849	2X9	22.86	20.32	1000	MDS2418422	2X22	55.88	53.34	1000	MDS2418435	2X35	88.90	86.36	1000
MDS2418410	2X10	25.40	22.86	1000	MDS2418423	2X23	58.42	55.88	1000	MDS2418436	2X36	91.44	88.90	1000
MDS2418411	2X11	27.94	25.40	1000	MDS2418424	2X24	60.96	58.42	1000	MDS2418437	2X37	93.98	91.44	1000
MDS2418412	2X12	30.48	27.94	1000	MDS2418425	2X25	63.50	60.96	1000	MDS2418438	2X38	96.52	93.98	1000
MDS2418413	2X13	33.02	30.48	1000	MDS2418426	2X26	66.04	63.50	1000	MDS2418439	2X39	99.06	96.52	1000
MDS2418414	2X14	35.56	33.02	1000	MDS2418427	2X27	68.58	66.04	1000	MDS2418440	2X40	101.60	99.06	1000

24184 Wire to Board Connectors - DIP Type



CONNECTOR - Top Entry

Part No.: MF241841~MF2418440

產品編號

Material: Housing: P.B.T 94V-0, Black

材質 塑膠座 黑色

Contact Pin: Brass, Gold-flash

接觸針 黃銅, 鍍金

Suitable Contact: --

配合端子

Suitable Housing: MD241841~MD2418440

配合塑膠

MD241841R~MD2418440R

Applicable Wire: AWG# 24~28

適用電線

Square Contact Pin: 0.80x0.3mm

方型接觸針

PERFORMANCE

Electrical Rating: AC/DC 200V 3A

額定電壓電流

Insulation Resistance: 5000MΩ min.

絕緣阻抗

Withstanding Voltage: 500V AC/minute

耐電壓

Temperature Range: -40°C~+105°C

適用溫度

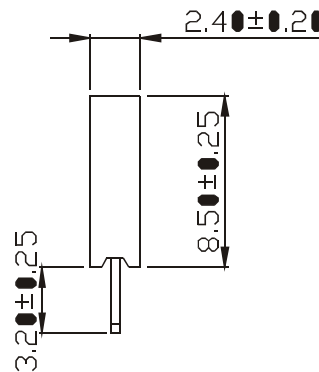
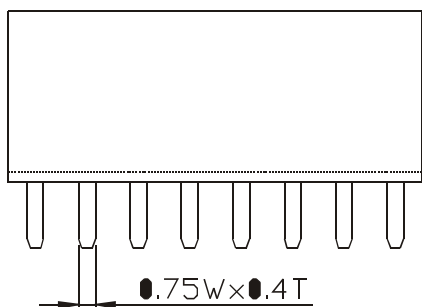
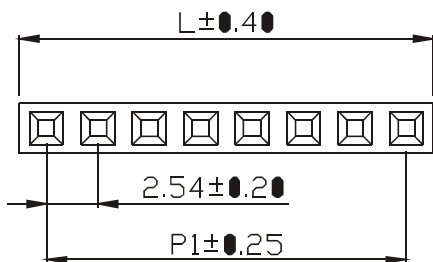
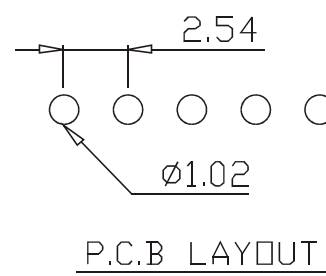

2.54mm

Part No.	POS.	L	P1	Pack.
MF241841	1	3.14		1000
MF241842	2	5.68	2.54	1000
MF241843	3	8.22	5.08	1000
MF241844	4	10.76	7.62	1000
MF241845	5	13.30	10.16	1000
MF241846	6	15.84	12.70	1000
MF241847	7	18.38	15.24	1000
MF241848	8	20.92	17.78	1000
MF241849	9	23.46	20.32	1000
MF2418410	10	26.00	22.86	1000
MF2418411	11	28.54	25.40	1000
MF2418412	12	31.08	27.94	1000
MF2418413	13	33.62	30.48	1000
MF2418414	14	36.16	33.02	1000

Part No.	POS.	L	P1	Pack.
MF2418415	15	38.70	35.56	1000
MF2418416	16	41.24	38.10	500
MF2418417	17	43.78	40.64	500
MF2418418	18	46.32	43.18	500
MF2418419	19	48.86	45.72	500
MF2418420	20	51.40	48.26	500
MF2418421	21	53.94	50.80	500
MF2418422	22	56.48	53.34	500
MF2418423	23	59.02	55.88	500
MF2418424	24	61.56	58.42	500
MF2418425	25	64.10	60.96	500
MF2418426	26	66.64	63.50	500
MF2418427	27	69.18	66.04	500
MF2418428	28	71.72	68.58	500

Part No.	POS.	L	P1	Pack.
MF2418429	29	74.26	71.12	500
MF2418430	30	76.80	73.66	500
MF2418431	31	79.34	76.20	200
MF2418432	32	81.88	78.74	200
MF2418433	33	84.42	81.28	200
MF2418434	34	86.96	83.82	200
MF2418435	35	89.50	86.36	200
MF2418436	36	92.04	88.90	200
MF2418437	37	94.58	91.44	200
MF2418438	38	97.12	93.98	200
MF2418439	39	99.66	96.52	200
MF2418440	40	102.20	99.06	200

Unit: mm

24184 Wire to Board Connectors - DIP Type



CONNECTOR - Top Entry

Part No.: MF241843~MF2418440 RF:A

產品編號

Material: Housing: P.B.T 94V-0, Black

材質 塑膠座 黑色

Contact Pin: Brass, Gold-flash

接觸針 黃銅, 鍍金

Suitable Contact: --

配合端子

Suitable Housing: M241843~M2418440

配合塑膠

M241843R~M2418440R

Applicable Wire: AWG# 24~28

適用電線

Square Contact Pin: 0.80x0.3mm

方型接觸針

PERFORMANCE

Electrical Rating: AC/DC 250V 3A

額定電壓電流

Insulation Resistance: 1000MΩ min.

絕緣阻抗

Withstanding Voltage: 500V AC/minute

耐電壓

Temperature Range: -40°C~+105°C

適用溫度

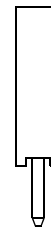
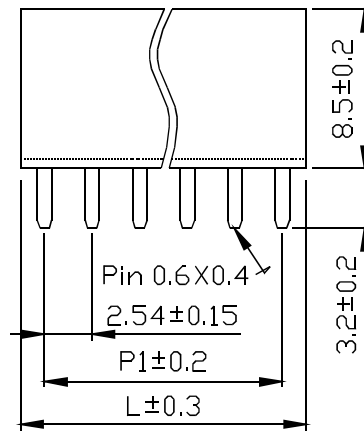
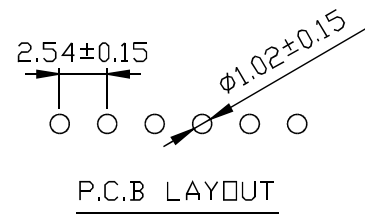
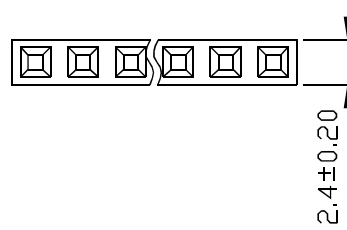

$$L = 2.54 \times \text{No. of Contacts} + 0.5$$

$$P1 = 2.54 \times \text{No. of Contacts} - 2.54$$

Note: Letters RF:A to be added follows the part number, i.e MF241843 RF:A.

Unit: mm

Part No.	POS.	L	P1	Pack.
MF241843	3	8.12	5.08	500
MF241844	4	10.66	7.62	350
MF241845	5	13.20	10.16	250
MF241846	6	15.74	12.70	1190
MF241847	7	18.28	15.24	1050
MF241848	8	20.82	17.78	910
MF241849	9	23.36	20.32	770
MF2418410	10	25.90	22.86	700
MF2418411	11	28.44	25.40	630
MF2418412	12	30.98	27.94	560
MF2418413	13	33.52	30.48	560
MF2418414	14	36.06	33.02	490
MF2418415	15	38.60	35.56	490

Part No.	POS.	L	P1	Pack.
MF2418416	16	41.14	38.10	420
MF2418417	17	43.68	40.64	420
MF2418418	18	46.22	43.18	350
MF2418419	19	48.76	45.72	350
MF2418420	20	51.30	48.26	350
MF2418421	21	53.84	50.80	350
MF2418422	22	56.38	53.34	280
MF2418423	23	58.92	55.88	280
MF2418424	24	61.46	58.42	280
MF2418425	25	64.00	60.96	280
MF2418426	26	66.54	63.50	280
MF2418427	27	69.08	66.04	210
MF2418428	28	71.62	68.58	210

Part No.	POS.	L	P1	Pack.
MF2418429	29	74.16	71.12	210
MF2418430	30	76.70	73.66	210
MF2418431	31	79.24	76.20	210
MF2418432	32	81.78	78.74	210
MF2418433	33	84.32	81.28	210
MF2418434	34	86.86	83.82	210
MF2418435	35	89.40	86.36	210
MF2418436	36	91.94	88.90	140
MF2418437	37	94.48	91.44	140
MF2418438	38	97.02	93.98	140
MF2418439	39	99.56	96.52	140
MF2418440	40	102.10	99.06	140

2.54mm

24184 Wire to Board Connectors - DIP Type



CONNECTOR - Top Entry

Part No.: MF241841R~MF2418440R

產品編號

Material: Housing: P.B.T 94V-0, Black

材質 塑膠座 黑色

Contact Pin: Brass, Gold-flash

接觸針 黃銅, 鍍金

Suitable Contact: --

配合端子

Suitable Housing: M241841~M2418440

配合塑膠

M241841R~M2418440R

Applicable Wire: AWG# 24~28

適用電線

Square Contact Pin: 0.80x0.3mm

方型接觸針

PERFORMANCE

Electrical Rating: AC/DC 500V 3A

額定電壓電流

Insulation Resistance: 5000MΩ min.

絕緣阻抗

Withstanding Voltage: 500V AC/minute

耐電壓

Temperature Range: -40°C~+105°C

適用溫度

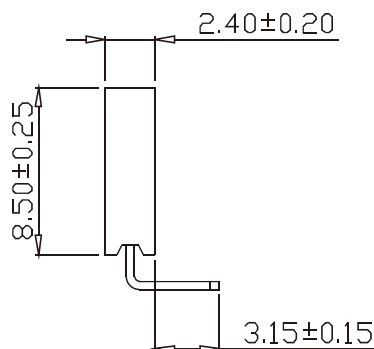
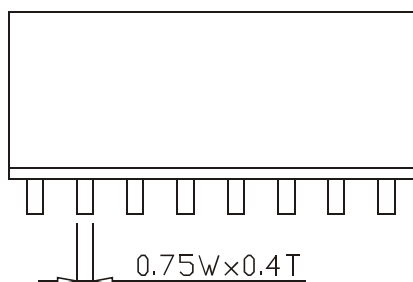
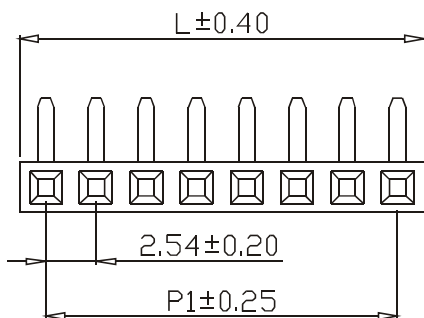
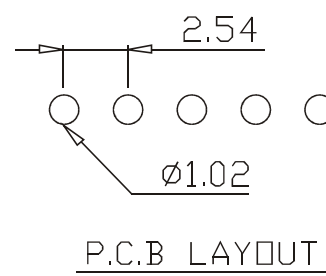

2.54mm

Part No.	POS.	L	P1	Pack.
MF241841R	1	3.14		1000
MF241842R	2	5.68	2.54	1000
MF241843R	3	8.22	5.08	1000
MF241844R	4	10.76	7.62	1000
MF241845R	5	13.30	10.16	1000
MF241846R	6	15.84	12.70	1000
MF241847R	7	18.38	15.24	1000
MF241848R	8	20.92	17.78	1000
MF241849R	9	23.46	20.32	1000
MF2418410R	10	26.00	22.86	1000
MF2418411R	11	28.54	25.40	1000
MF2418412R	12	31.08	27.94	1000
MF2418413R	13	33.62	30.48	1000
MF2418414R	14	36.16	33.02	1000

Part No.	POS.	L	P1	Pack.
MF2418415R	15	38.70	35.56	1000
MF2418416R	16	41.24	38.10	500
MF2418417R	17	43.78	40.64	500
MF2418418R	18	46.32	43.18	500
MF2418419R	19	48.86	45.72	500
MF2418420R	20	51.40	48.26	500
MF2418421R	21	53.94	50.80	300
MF2418422R	22	56.48	53.34	300
MF2418423R	23	59.02	55.88	300
MF2418424R	24	61.56	58.42	300
MF2418425R	25	64.10	60.96	200
MF2418426R	26	66.64	63.50	200
MF2418427R	27	69.18	66.04	200
MF2418428R	28	71.72	68.58	200

Part No.	POS.	L	P1	Pack.
MF2418429R	29	74.26	71.12	200
MF2418430R	30	76.80	73.66	200
MF2418431R	31	79.34	76.20	200
MF2418432R	32	81.88	78.74	200
MF2418433R	33	84.42	81.28	200
MF2418434R	34	86.96	83.82	200
MF2418435R	35	89.50	86.36	200
MF2418436R	36	92.04	88.90	200
MF2418437R	37	94.58	91.44	200
MF2418438R	38	97.12	93.98	200
MF2418439R	39	99.66	96.52	200
MF2418440R	40	102.20	99.06	200
MF2418440R	40	101.60	99.06	200

Unit: mm

24184 Wire to Board Connectors - DIP Type



CONNECTOR - Top Entry

Part No.: MF241842R~MF2418440R RF:A

產品編號

Material: Housing: P.B.T 94V-0, Black

材質 塑膠座 黑色

Contact Pin: Brass, Gold-flash

接觸針 黃銅, 鍍金

Suitable Contact: --

配合端子

Suitable Housing: M241842~M2418440

配合塑膠

M241842R~M2418440R

Applicable Wire: AWG# 24~28

適用電線

Square Contact Pin: 0.80x0.3mm

方型接觸針

PERFORMANCE

Electrical Rating: AC/DC 500V 3A

額定電壓電流

Insulation Resistance: 5000MΩ min.

絕緣阻抗

Withstanding Voltage: 500V AC/minute

耐電壓

Temperature Range: -40°C~+105°C

適用溫度

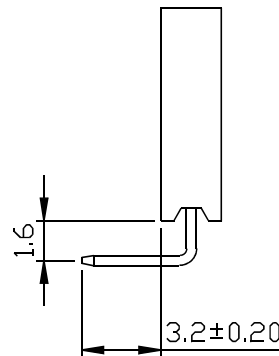
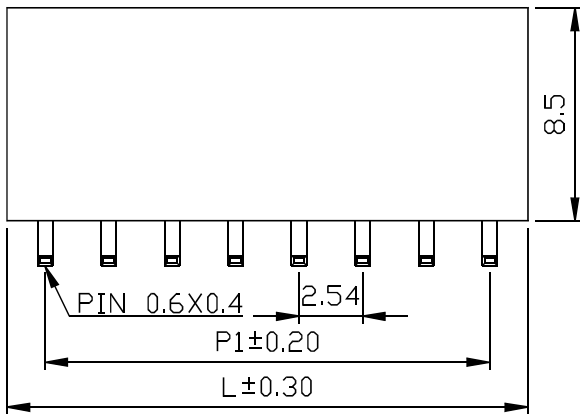
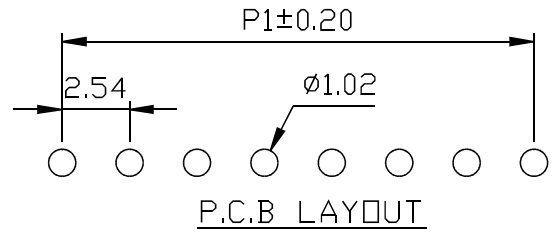
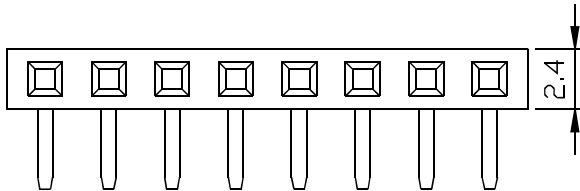

TOLERANCE	
.0	±0.20
.00	±0.15
.000	±0.05

2.54mm

Unit: mm

Part No.	RF	POS.	L	P1	Pack.	Part No.	RF	POS.	L	P1	Pack.	Part No.	RF	POS.	L	P1	Pack.
MF241842R	A	2	5.58	2.54	1000	MF2418415R	A	15	38.60	35.56	420	MF2418428R	A	28	71.62	68.58	180
MF241843R	A	3	8.12	5.08	500	MF2418416R	A	16	41.14	38.10	360	MF2418429R	A	29	74.16	71.12	180
MF241844R	A	4	10.66	7.62	350	MF2418417R	A	17	43.68	40.64	360	MF2418430R	A	30	76.70	73.66	180
MF241845R	A	5	13.20	10.16	250	MF2418418R	A	18	46.22	43.18	360	MF2418431R	A	31	79.24	76.20	180
MF241846R	A	6	15.74	12.70	1020	MF2418419R	A	19	48.76	45.72	300	MF2418432R	A	32	81.78	78.74	180
MF241847R	A	7	18.28	15.24	900	MF2418420R	A	20	51.30	48.26	300	MF2418433R	A	33	84.32	81.28	180
MF241848R	A	8	20.82	17.78	780	MF2418421R	A	21	53.84	50.80	300	MF2418434R	A	34	86.86	83.82	180
MF241849R	A	9	23.36	20.32	720	MF2418422R	A	22	56.38	53.34	300	MF2418435R	A	35	89.40	86.36	180
MF2418410R	A	10	25.90	22.86	600	MF2418423R	A	23	58.92	55.88	240	MF2418436R	A	36	91.94	88.90	180
MF2418411R	A	11	28.44	25.40	540	MF2418424R	A	24	61.46	58.42	240	MF2418437R	A	37	94.48	91.44	120
MF2418412R	A	12	30.98	27.94	540	MF2418425R	A	25	64.00	60.96	240	MF2418438R	A	38	97.02	93.98	120
MF2418413R	A	13	33.52	30.48	480	MF2418426R	A	26	66.54	63.50	240	MF2418439R	A	39	99.56	96.52	120
MF2418414R	A	14	36.06	33.02	420	MF2418427R	A	27	69.08	66.04	240	MF2418440R	A	40	102.10	99.06	120

24184 Wire to Board Connectors - DIP Type

CONNECTOR - Top Entry

Part No.: **MDF241842~MDF2418440**

產品編號

Material: Housing: P.B.T 94V-0, Black

材質 塑膠座 黑色

Contact Pin: Brass, Gold-flash

接觸針 黃銅, 鍍金

Suitable Contact: --

配合端子

Suitable Housing: MD241842~MD2418440

配合塑膠

MD241842R~MD2418440R

Applicable Wire: AWG# 24~28

適用電線

Square Contact Pin: 0.80x0.3mm

方型接觸針

PERFORMANCE

Electrical Rating: AC/DC 250V 3A

額定電壓電流

Insulation Resistance: 5000MΩ min.

絕緣阻抗

Withstanding Voltage: 500V AC/minute

耐電壓

Temperature Range: -40°C~+105°C

適用溫度

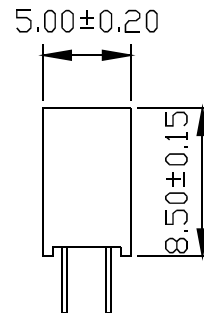
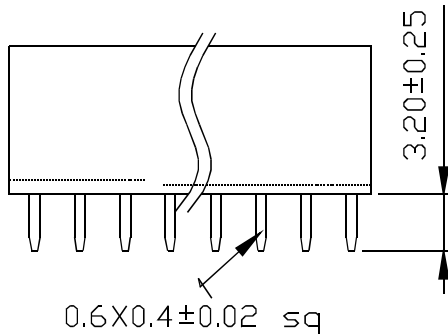
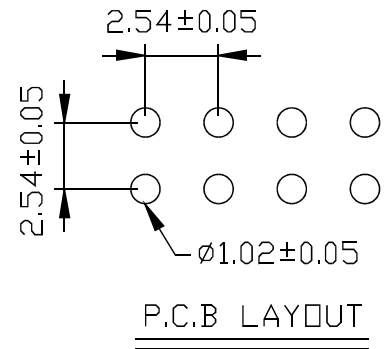
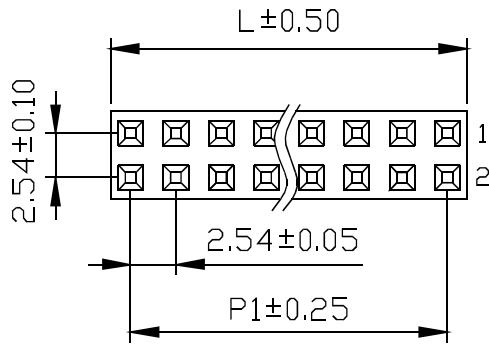

Part No.	POS.	L	P1	Pack.	Part No.	POS.	L	P1	Pack.	Part No.	POS.	L	P1	Pack.
MDF241842	2X2	5.58	2.54	2000	MDF2418415	2X15	38.60	35.56	1000	MDF2418428	2X28	71.62	68.58	500
MDF241843	2X3	8.12	5.08	2000	MDF2418416	2X16	41.14	38.10	1000	MDF2418429	2X29	74.16	71.12	500
MDF241844	2X4	10.66	7.62	2000	MDF2418417	2X17	43.68	40.64	1000	MDF2418430	2X30	76.70	73.66	500
MDF241845	2X5	13.20	10.16	2000	MDF2418418	2X18	46.22	43.18	1000	MDF2418431	2X31	79.24	76.20	500
MDF241846	2X6	15.74	12.70	2000	MDF2418419	2X19	48.76	45.72	1000	MDF2418432	2X32	81.78	78.74	500
MDF241847	2X7	18.28	15.24	2000	MDF2418420	2X20	51.30	48.26	1000	MDF2418433	2X33	84.32	81.28	500
MDF241848	2X8	20.82	17.78	1000	MDF2418421	2X21	53.84	50.80	500	MDF2418434	2X34	86.86	83.82	500
MDF241849	2X9	23.36	20.32	1000	MDF2418422	2X22	56.38	53.34	500	MDF2418435	2X35	89.40	86.36	500
MDF2418410	2X10	25.90	22.86	1000	MDF2418423	2X23	58.92	55.88	500	MDF2418436	2X36	91.94	88.90	500
MDF2418411	2X11	28.44	25.40	1000	MDF2418424	2X24	61.46	58.42	500	MDF2418437	2X37	94.48	91.44	500
MDF2418412	2X12	30.98	27.94	1000	MDF2418425	2X25	64.00	60.96	500	MDF2418438	2X38	97.02	93.98	500
MDF2418413	2X13	33.52	30.48	1000	MDF2418426	2X26	66.54	63.50	500	MDF2418439	2X39	99.56	96.52	500
MDF2418414	2X14	36.06	33.02	1000	MDF2418427	2X27	69.08	66.04	500	MDF2418440	2X40	102.10	99.06	500

Unit: mm

2.54mm

24184 Wire to Board Connectors - DIP Type

CONNECTOR - Top Entry

Part No.: **MDF241842~MDF2418440 RF:A**
 產品編號

MDF241842~MDF2418440 RF:C

Material: Housing: P.B.T 94V-0, Black
 材質 塑膠座 黑色

Contact Pin: Brass, Gold-flash
 接觸針 黃銅, 鍍金

Suitable Contact: --
 配合端子

Suitable Housing: MD241842~MD2418440
 配合塑膠

MD241842R~MD2418440R

Applicable Wire: AWG# 24~28
 適用電線

Square Contact Pin: 0.60x0.4mm
 方型接觸針

PERFORMANCE

Electrical Rating: AC/DC 250V 3A
 額定電壓電流

Insulation Resistance: 1000MΩ min.
 絕緣阻抗

Withstanding Voltage: 500V AC/minute
 耐電壓

Temperature Range: -40°C~+105°C
 適用溫度

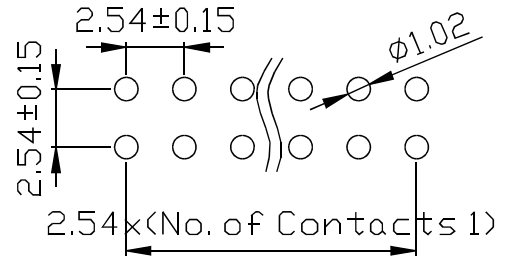
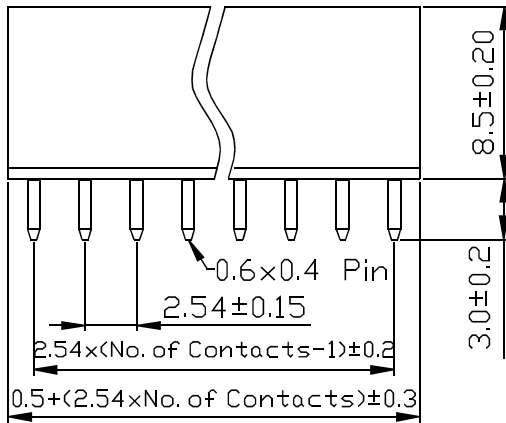
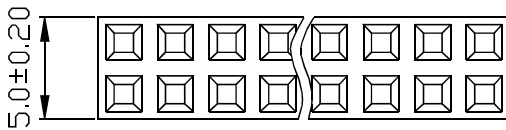

P.C.B LAYOUT

RF: A

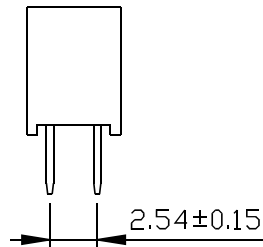

RF: C

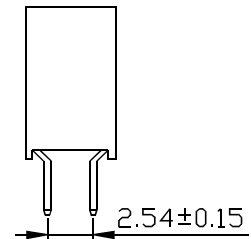

Note: Letters RF:A or RF:C to be added follows the part number, i.e MDF241842 RF:A or MDF241842 RF:C.

Unit: mm

Part No.	POS.	L	P1	Pack.	Part No.	POS.	L	P1	Pack.	Part No.	POS.	L	P1	Pack.
MDF241842	2X2	5.68	2.54	2000	MDF2418415	2X15	38.70	35.56	1000	MDF2418428	2X28	71.72	68.58	500
MDF241843	2X3	8.22	5.08	2000	MDF2418416	2X16	41.24	38.10	1000	MDF2418429	2X29	74.26	71.12	500
MDF241844	2X4	10.76	7.62	2000	MDF2418417	2X17	43.78	40.64	1000	MDF2418430	2X30	76.80	73.66	500
MDF241845	2X5	13.30	10.16	2000	MDF2418418	2X18	46.32	43.18	1000	MDF2418431	2X31	79.34	76.20	500
MDF241846	2X6	15.84	12.70	2000	MDF2418419	2X19	48.86	45.72	1000	MDF2418432	2X32	81.88	78.74	500
MDF241847	2X7	18.38	15.24	2000	MDF2418420	2X20	51.40	48.26	1000	MDF2418433	2X33	84.42	81.28	500
MDF241848	2X8	20.92	17.78	1000	MDF2418421	2X21	53.94	50.80	500	MDF2418434	2X34	86.96	83.82	500
MDF241849	2X9	23.46	20.32	1000	MDF2418422	2X22	56.48	53.34	500	MDF2418435	2X35	89.50	86.36	500
MDF2418410	2X10	26.00	22.86	1000	MDF2418423	2X23	59.02	55.88	500	MDF2418436	2X36	92.04	88.90	500
MDF2418411	2X11	28.54	25.40	1000	MDF2418424	2X24	61.56	58.42	500	MDF2418437	2X37	94.58	91.44	500
MDF2418412	2X12	31.08	27.94	1000	MDF2418425	2X25	64.10	60.96	500	MDF2418438	2X38	97.12	93.98	500
MDF2418413	2X13	33.62	30.48	1000	MDF2418426	2X26	66.64	63.50	500	MDF2418439	2X39	99.66	96.52	500
MDF2418414	2X14	36.16	33.02	1000	MDF2418427	2X27	69.18	66.04	500	MDF2418440	2X40	102.20	99.06	500

24184 Wire to Board Connectors

CONNECTOR - Side Entry

Part No.: **MDF241842R~MDF2418440R**

產品編號

Material: Housing: P.B.T 94V-0, Black

材質 塑膠座 黑色

Contact Pin: Brass, Gold-flash

接觸針 黃銅, 鍍金

Suitable Contact: --

配合端子

Suitable Housing: MD241842~MD2418440

配合塑膠

MD241842R~MD2418440R

Applicable Wire: AWG# 24~28

適用電線

Square Contact Pin: 0.80x0.3mm

方型接觸針

PERFORMANCE

Electrical Rating: AC/DC 250V 3A

額定電壓電流

Insulation Resistance: 5000MΩ min.

絕緣阻抗

Withstanding Voltage: 500V AC/minute

耐電壓

Temperature Range: -40°C~+105°C

適用溫度

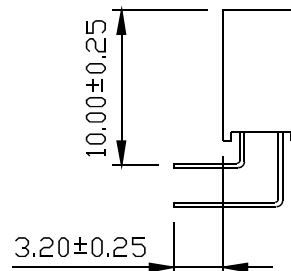
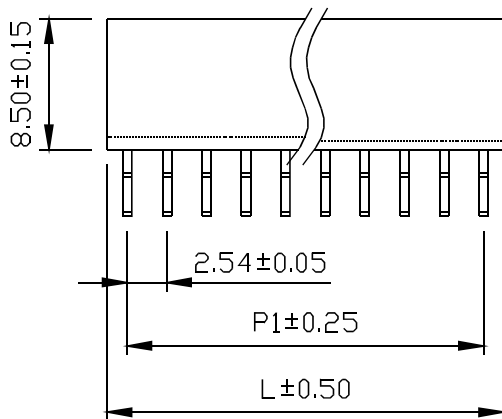
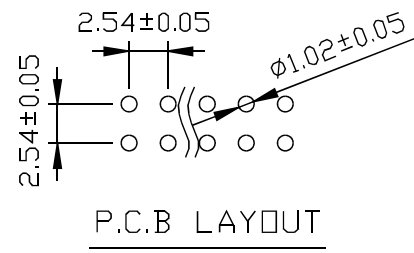
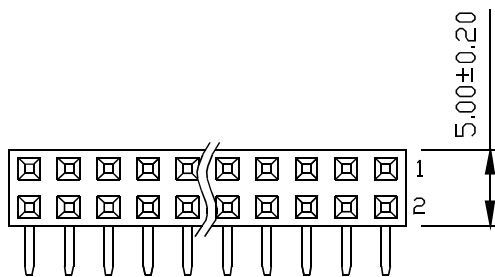

Unit: mm

Part No.	POS.	L	P1	Pack.	Part No.	POS.	L	P1	Pack.	Part No.	POS.	L	P1	Pack.
MDF241842R	2X2	5.58	2.54	2000	MDF2418415R	2X15	38.60	35.56	1000	MDF2418428R	2X28	71.62	68.58	500
MDF241843R	2X3	8.12	5.08	2000	MDF2418416R	2X16	41.14	38.10	1000	MDF2418429R	2X29	74.16	71.12	500
MDF241844R	2X4	10.66	7.62	2000	MDF2418417R	2X17	43.68	40.64	1000	MDF2418430R	2X30	76.70	73.66	500
MDF241845R	2X5	13.20	10.16	2000	MDF2418418R	2X18	46.22	43.18	1000	MDF2418431R	2X31	79.24	76.20	500
MDF241846R	2X6	15.74	12.70	2000	MDF2418419R	2X19	48.76	45.72	1000	MDF2418432R	2X32	81.78	78.74	500
MDF241847R	2X7	18.28	15.24	2000	MDF2418420R	2X20	51.30	48.26	1000	MDF2418433R	2X33	84.32	81.28	500
MDF241848R	2X8	20.82	17.78	1000	MDF2418421R	2X21	53.84	50.80	500	MDF2418434R	2X34	86.86	83.82	500
MDF241849R	2X9	23.36	20.32	1000	MDF2418422R	2X22	56.38	53.34	500	MDF2418435R	2X35	89.40	86.36	500
MDF2418410R	2X10	25.90	22.86	1000	MDF2418423R	2X23	58.92	55.88	500	MDF2418436R	2X36	91.94	88.90	500
MDF2418411R	2X11	28.44	25.40	1000	MDF2418424R	2X24	61.46	58.42	500	MDF2418437R	2X37	94.48	91.44	500
MDF2418412R	2X12	30.98	27.94	1000	MDF2418425R	2X25	64.00	60.96	500	MDF2418438R	2X38	97.02	93.98	500
MDF2418413R	2X13	33.52	30.48	1000	MDF2418426R	2X26	66.54	63.50	500	MDF2418439R	2X39	99.56	96.52	500
MDF2418414R	2X14	36.06	33.02	1000	MDF2418427R	2X27	69.08	66.04	500	MDF2418440R	2X40	102.10	99.06	500

2.54mm

24184 Wire to Board Connectors



CONNECTOR - Top Entry

Part No.: M241841~M2418440

產品編號

Material: Housing: P.B.T 94V-0

材質 塑膠座

Contact Pin: Brass, Gold-flash

接觸針 黃銅, 鍍金

Suitable Contact: 24184BS-2 24184BS-00

配合端子

Suitable Housing: P241841~P2418440

配合塑膠

Applicable Wire: AWG# 24~28

適用電線

Square Contact Pin: 0.64±0.02mm

方型接觸針

PERFORMANCE

Electrical Rating: AC/DC 250V 3A

額定電壓電流

Insulation Resistance: 500MΩ min.

絕緣阻抗

Withstanding Voltage: 500V AC/minute

耐電壓

Temperature Range: -40°C~+105°C

適用溫度

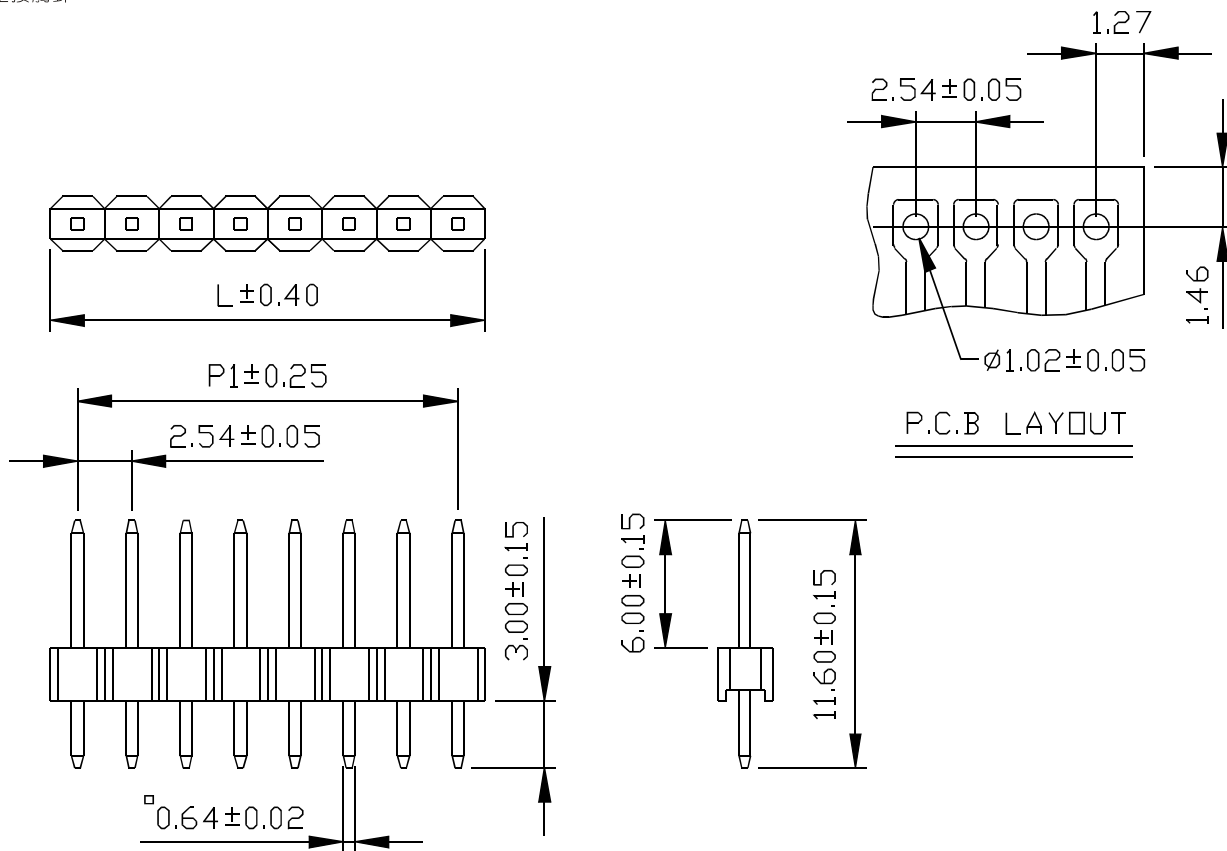

2.54mm

Part No.	POS.	L	P1	Pack.	Part No.	POS.	L	P1	Pack.	Part No.	POS.	L	P1	Pack.
M241841	1	2.54	2.54	5000	M2418415	15	38.10	35.56	1000	M2418429	29	73.66	71.12	500
M241842	2	5.08	2.54	2000	M2418416	16	40.64	38.10	500	M2418430	30	76.20	73.66	500
M241843	3	7.62	5.08	2000	M2418417	17	43.18	40.64	500	M2418431	31	78.74	76.20	200
M241844	4	10.16	7.62	2000	M2418418	18	45.72	43.18	500	M2418432	32	81.28	78.74	200
M241845	5	12.70	10.16	2000	M2418419	19	48.26	45.72	500	M2418433	33	83.82	81.28	200
M241846	6	15.24	12.70	2000	M2418420	20	50.80	48.26	500	M2418434	34	86.36	83.82	200
M241847	7	17.78	15.24	2000	M2418421	21	53.34	50.80	500	M2418435	35	88.90	86.36	200
M241848	8	20.32	17.78	2000	M2418422	22	55.88	53.34	500	M2418436	36	91.44	88.90	200
M241849	9	22.86	20.32	1000	M2418423	23	58.42	55.88	500	M2418437	37	93.98	91.44	200
M2418410	10	25.40	22.86	1000	M2418424	24	60.96	58.42	500	M2418438	38	96.52	93.98	200
M2418411	11	27.94	25.40	1000	M2418425	25	63.50	60.96	500	M2418439	39	99.06	96.52	200
M2418412	12	30.48	27.94	1000	M2418426	26	66.04	63.50	500	M2418440	40	101.60	99.06	200
M2418413	13	33.02	30.48	1000	M2418427	27	68.58	66.04	500					
M2418414	14	35.56	33.02	1000	M2418428	28	71.12	68.58	500					

Unit: mm

24184 Wire to Board Connectors



CONNECTOR - Side Entry

Part No.: **M241841R~M2418440R**

產品編號

Material: Housing: P.B.T 94V-0

材質 塑膠座

Contact Pin: Brass, Gold-flash

接觸針 黃銅, 鍍金

Suitable Contact: 24184BS-2 24184BS-00

配合端子

Suitable Housing: P241841~P2418440

配合塑膠

MDF241842~MDF2418440

MDF241842R~MDF2418440R

Applicable Wire: AWG# 24~28

適用電線

Square Contact Pin: 0.64 ± 0.02 mm

方型接觸針

PERFORMANCE

Electrical Rating: AC/DC 250V 3A

額定電壓電流

Insulation Resistance: 500M Ω min.

絕緣阻抗

Withstanding Voltage: 500V AC/minute

耐電壓

Temperature Range: -40 $^{\circ}$ C~+105 $^{\circ}$ C

適用溫度

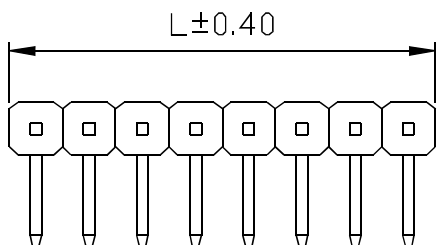

2.54 ± 0.05

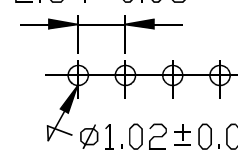

P.C.B. LAYOUT

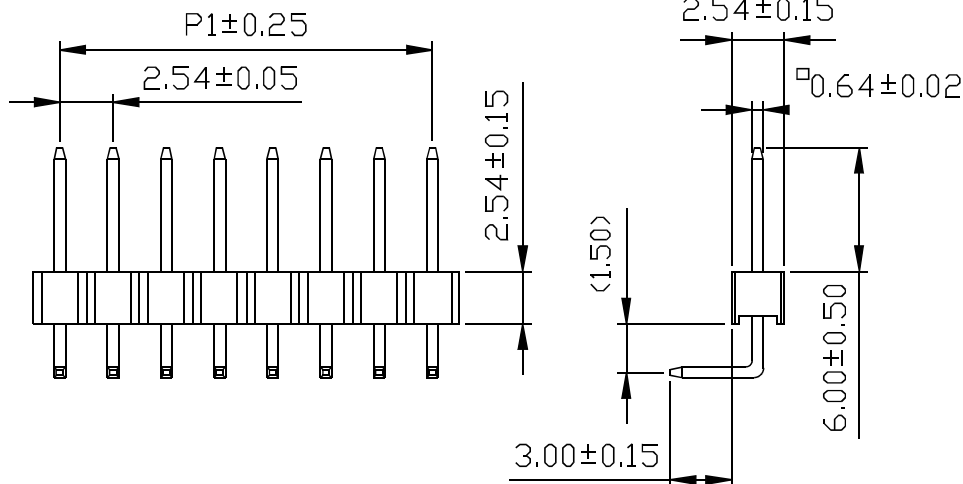

Unit: mm

PartNo.	POS.	L	P1	Pack.	PartNo.	POS.	L	P1	Pack.	PartNo.	POS.	L	P1	Pack.
M241842R	1	2.54	2.54	1000	M2418415R	15	38.10	35.56	1000	M2418429R	29	73.66	71.12	500
M241842R	2	5.08	2.54	1000	M2418416R	16	40.64	38.10	500	M2418430R	30	76.20	73.66	500
M241843R	3	7.62	5.08	1000	M2418417R	17	43.18	40.64	500	M2418431R	31	78.74	76.20	200
M241844R	4	10.16	7.62	1000	M2418418R	18	45.72	43.18	500	M2418432R	32	81.28	78.74	200
M241845R	5	12.70	10.16	1000	M2418419R	19	48.26	45.72	500	M2418433R	33	83.82	81.28	200
M241846R	6	15.24	12.70	1000	M2418420R	20	50.80	48.26	500	M2418434R	34	86.36	83.82	200
M241847R	7	17.78	15.24	1000	M2418421R	21	53.34	50.80	500	M2418435R	35	88.90	86.36	200
M241848R	8	20.32	17.78	1000	M2418422R	22	55.88	53.34	500	M2418436R	36	91.44	88.90	500
M241849R	9	22.86	20.32	1000	M2418423R	23	58.42	55.88	500	M2418437R	37	93.98	91.44	200
M2418410R	10	25.40	22.86	1000	M2418424R	24	60.96	58.42	500	M2418438R	38	96.52	93.98	200
M2418411R	11	27.94	25.40	1000	M2418425R	25	63.50	60.96	500	M2418439R	39	99.06	96.52	200
M2418412R	12	30.48	27.94	1000	M2418426R	26	66.04	63.50	500	M2418440R	40	101.60	99.06	200
M2418413R	13	33.02	30.48	1000	M2418427R	27	68.58	66.04	500					
M2418414R	14	35.56	33.02	1000	M2418428R	28	71.12	68.58	500					

2.54mm

24184 Wire to Board Connectors



CONNECTOR - Top Entry

Part No.: MD241842~MD2418440

產品編號

Material: Housing: P.B.T 94V-0

材質 塑膠座

Contact Pin: Brass, Gold-flash

接觸針 黃銅, 鍍金

Suitable Contact: 24184BS-2 24184BS-00

配合端子

Suitable Housing: PD241842~PD2418440

配合塑膠

MDF241842~MDF2418440

MDF241842R~MDF2418440R

Applicable Wire: AWG# 24~28

適用電線

Square Contact Pin: 0.64±0.02mm

方型接觸針

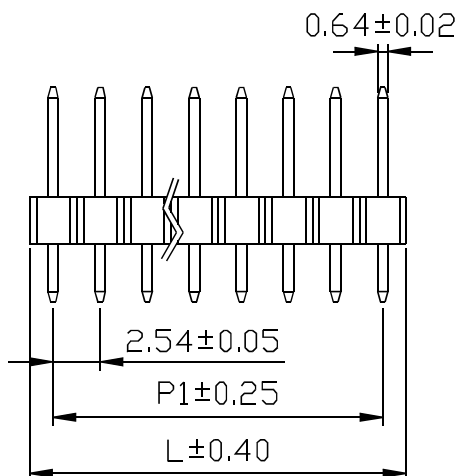
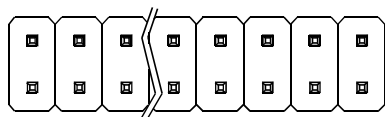

PERFORMANCE

Electrical Rating: AC/DC 250V 3A

額定電壓電流

Insulation Resistance: 500MΩ min.

絕緣阻抗

Withstanding Voltage: 500V AC/minute

耐電壓

Temperature Range: -40°C~+105°C

適用溫度

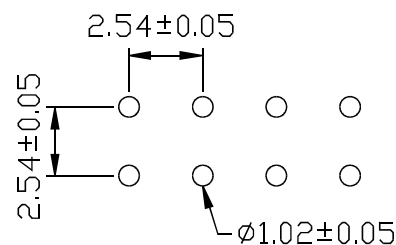

P.C.B LAYOUT

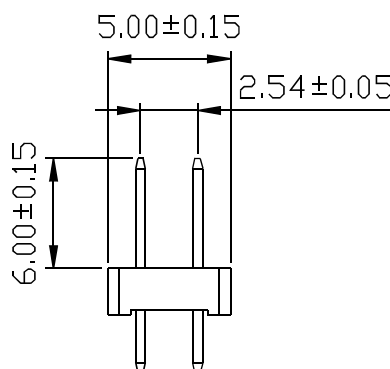

2.54mm

Unit: mm

Part No.	POS.	L	P1	Pack.	Part No.	POS.	L	P1	Pack.	Part No.	POS.	L	P1	Pack.
MD241842	2X2	5.08	2.54	1000	MD2418416	2X16	40.64	38.10	300	MD2418430	2X30	76.20	73.66	200
MD241843	2X3	7.62	5.08	1000	MD2418417	2X17	43.18	40.64	300	MD2418431	2X31	78.74	76.20	200
MD241844	2X4	10.16	7.62	1000	MD2418418	2X18	45.72	43.18	200	MD2418432	2X32	81.28	78.74	200
MD241845	2X5	12.70	10.16	1000	MD2418419	2X19	48.26	45.72	200	MD2418433	2X33	83.82	81.28	200
MD241846	2X6	15.24	12.70	1000	MD2418420	2X20	50.80	48.26	200	MD2418434	2X34	86.36	83.82	200
MD241847	2X7	17.78	15.24	500	MD2418421	2X21	53.34	50.80	200	MD2418435	2X35	88.90	86.36	200
MD241848	2X8	20.32	17.78	500	MD2418422	2X22	55.88	53.34	200	MD2418436	2X36	91.44	88.90	200
MD241849	2X9	22.86	20.32	500	MD2418423	2X23	58.42	55.88	200	MD2418437	2X37	93.98	91.44	200
MD2418410	2X10	25.40	22.86	500	MD2418424	2X24	60.96	58.42	200	MD2418438	2X38	96.52	93.98	200
MD2418411	2X11	27.94	25.40	500	MD2418425	2X25	63.50	60.96	200	MD2418439	2X39	99.06	96.52	200
MD2418412	2X12	30.48	27.94	300	MD2418426	2X26	66.04	63.50	200	MD2418440	2X40	101.60	99.06	200
MD2418413	2X13	33.02	30.48	300	MD2418427	2X27	68.58	66.04	200					
MD2418414	2X14	35.56	33.02	300	MD2418428	2X28	71.12	68.58	200					
MD2418415	2X15	38.10	35.56	300	MD2418429	2X29	73.66	71.12	200					

24184 Wire to Board Connectors

CONNECTOR - Side Entry

Part No.: MD241842R~MD2418440R

產品編號

Material: Housing: P.B.T 94V-0

材質 塑膠座

Contact Pin: Brass, Gold-flash

接觸針 黃銅, 鍍金

Suitable Contact: 24184BS-2 24184BS-00

配合端子

Suitable Housing: PD241842~PD2418440

配合塑膠

MDF241842~MDF2418440

MDF241842R~MDF2418440R

Applicable Wire: AWG# 24~28

適用電線

Square Contact Pin: 0.64±0.02mm

方型接觸針

PERFORMANCE

Electrical Rating: AC/DC 500V 3A

額定電壓電流

Insulation Resistance: 500MΩ min.

絕緣阻抗

Withstanding Voltage: 500V AC/minute

耐電壓

Temperature Range: -40°C~+105°C

適用溫度

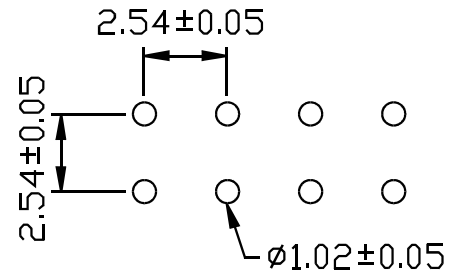
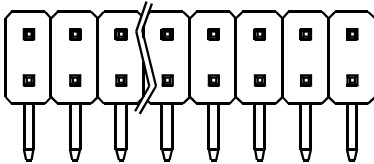

P.C.B LAYOUT

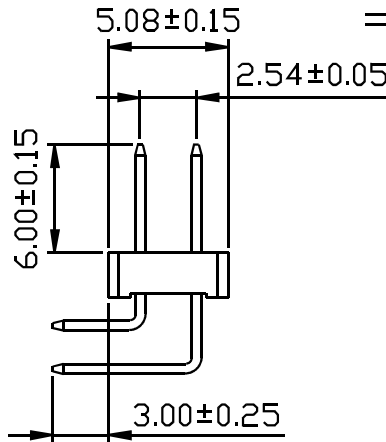
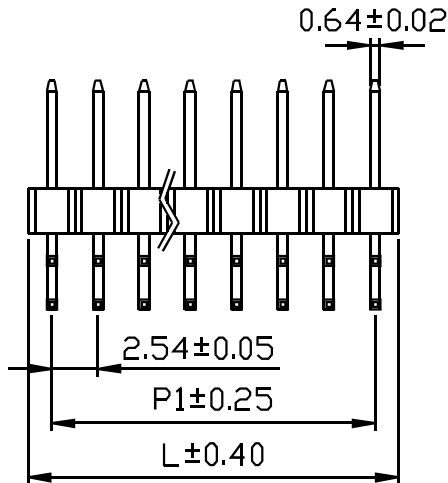

Part No.	POS.	L	P1	Pack.	Part No.	POS.	L	P1	Pack.	Part No.	POS.	L	P1	Pack.
MD241842R	2X2	5.08	2.54	1000	MD2418416R	2X16	40.64	38.10	300	MD2418430R	2X30	76.20	73.66	200
MD241843R	2X3	7.62	5.08	1000	MD2418417R	2X17	43.18	40.64	300	MD2418431R	2X31	78.74	76.20	200
MD241844R	2X4	10.16	7.62	1000	MD2418418R	2X18	45.72	43.18	200	MD2418432R	2X32	81.28	78.74	200
MD241845R	2X5	12.70	10.16	1000	MD2418419R	2X19	48.26	45.72	200	MD2418433R	2X33	83.82	81.28	200
MD241846R	2X6	15.24	12.70	1000	MD2418420R	2X20	50.80	48.26	200	MD2418434R	2X34	86.36	83.82	200
MD241847R	2X7	17.78	15.24	500	MD2418421R	2X21	53.34	50.80	200	MD2418435R	2X35	88.90	86.36	200
MD241848R	2X8	20.32	17.78	500	MD2418422R	2X22	55.88	53.34	200	MD2418436R	2X36	91.44	88.90	200
MD241849R	2X9	22.86	20.32	500	MD2418423R	2X23	58.42	55.88	200	MD2418437R	2X37	93.98	91.44	200
MD2418410R	2X10	25.40	22.86	500	MD2418424R	2X24	60.96	58.42	200	MD2418438R	2X38	96.52	93.98	200
MD2418411R	2X11	27.94	25.40	500	MD2418425R	2X25	63.50	60.96	200	MD2418439R	2X39	99.06	96.52	200
MD2418412R	2X12	30.48	27.94	300	MD2418426R	2X26	66.04	63.50	200	MD2418440R	2X40	101.60	99.06	200
MD2418413R	2X13	33.02	30.48	300	MD2418427R	2X27	68.58	66.04	200					
MD2418414R	2X14	35.56	33.02	300	MD2418428R	2X28	71.12	68.58	200					
MD2418415R	2X15	38.10	35.56	300	MD2418429R	2X29	73.66	71.12	200					

Unit: mm

2.54mm

24184 Wire to Board Connectors



HOUSING

Part No.: P241841~P2418440

產品編號

Material: Noryl 94V-1 Black

材質

Suitable Contact: 24184BS-2 24184BS-00

配合端子

Suitable Connector: M241841~M2418440

配合公座

M241841R~M2418440R

MS241841~MS2418440

Applicable Wire: AWG# 24~28

適用電線

PERFORMANCE

Electrical Rating: AC/DC 250V 3A

額定電壓電流

Insulation Resistance: 1000MΩ min.

絕緣阻抗

Withstanding Voltage: 1000V AC/minute

耐電壓

Temperature Range: -25°C~+85°C

適用溫度



Part No.: PIN24184 Jumper

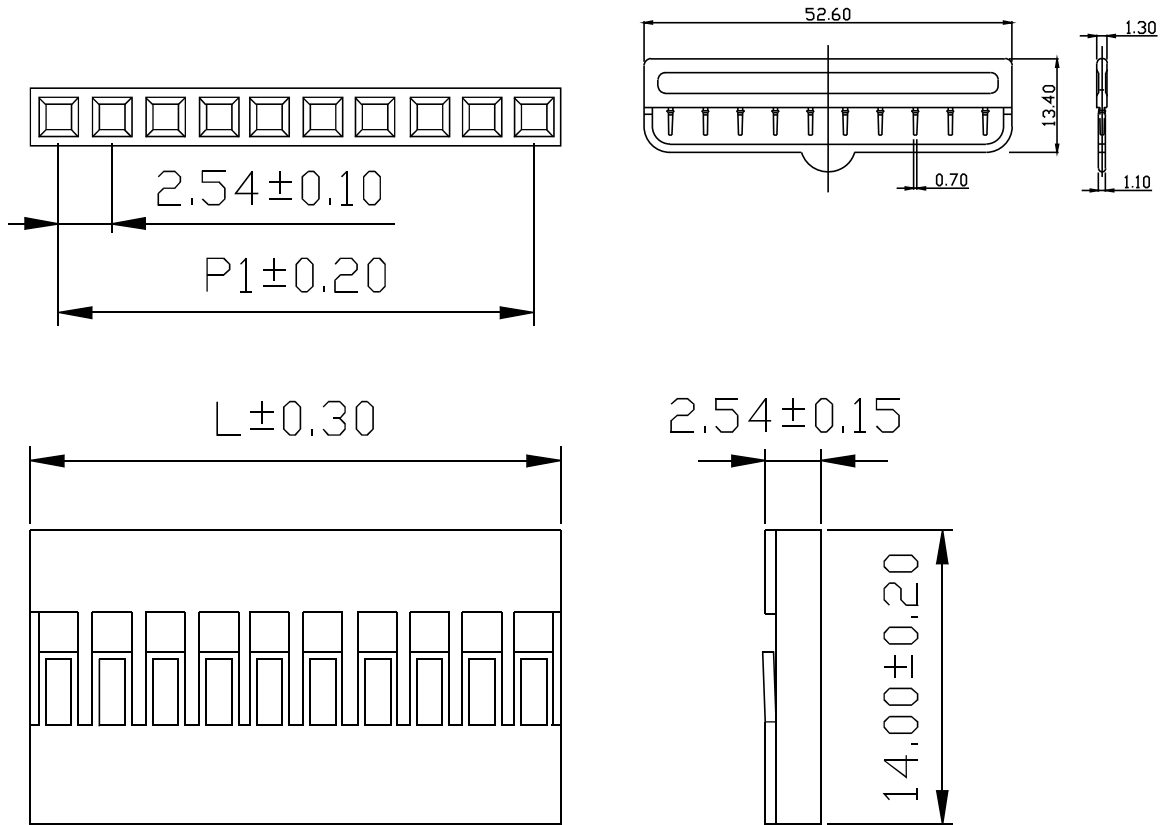

PartNo.	POS.	L	P1	Pack.	PartNo.	POS.	L	P1	Pack.	PartNo.	POS.	L	P1	Pack.
P241841	1	2.54	2.54	2000	P2418415	15	38.10	35.56	500	P2418429	29	73.66	71.12	250
P241842	2	5.08	2.54	1000	P2418416	16	40.64	38.10	500	P2418430	30	76.20	73.66	250
P241843	3	7.62	5.08	1000	P2418417	17	43.18	40.64	500	P2418431	31	78.74	76.20	250
P241844	4	10.16	7.62	1000	P2418418	18	45.72	43.18	500	P2418432	32	81.28	78.74	250
P241845	5	12.70	10.16	1000	P2418419	19	48.26	45.72	500	P2418433	33	83.82	81.28	250
P241846	6	15.24	12.76	1000	P2418420	20	50.80	48.26	500	P2418434	34	86.36	83.82	250
P241847	7	17.78	15.24	1000	P2418421	21	53.34	50.80	500	P2418435	35	88.90	86.36	250
P241848	8	20.32	17.78	1000	P2418422	22	55.88	53.34	500	P2418436	36	91.44	88.90	250
P241849	9	22.86	20.32	1000	P2418423	23	58.42	55.88	500	P2418437	37	93.98	91.44	250
P2418410	10	25.40	22.86	500	P2418424	24	60.96	58.42	500	P2418438	38	96.52	93.98	250
P2418411	11	27.94	25.40	500	P2418425	25	63.50	60.96	250	P2418439	39	99.06	96.52	250
P2418412	12	30.48	27.94	500	P2418426	26	66.04	63.50	250	P2418440	40	101.60	99.06	250
P2418413	13	33.02	30.48	500	P2418427	27	68.58	66.04	250					
P2418414	14	35.56	33.02	500	P2418428	28	71.12	68.58	250					

Unit: mm

24184 Wire to Board Connectors



HOUSING

Part No.: PD241842~PD2418440

產品編號

Material: Noryl 94V-1 Black

材質

Suitable Contact: 24184BS-2 24184BS-00

配合端子

Suitable Connector: MD241842~MD2418440

配合公座

MD241842R~MD2418440R

MDS241842~MDS2418440

Applicable Wire: AWG#24~28

適用電線

PERFORMANCE

Electrical Rating: AC/DC 250V 3A

額定電壓電流

Insulation Resistance: 1000MΩ min.

絕緣阻抗

Withstanding Voltage: 1000V AC/minute

耐電壓

Temperature Range: -25°C~+85°C

適用溫度



2.54mm

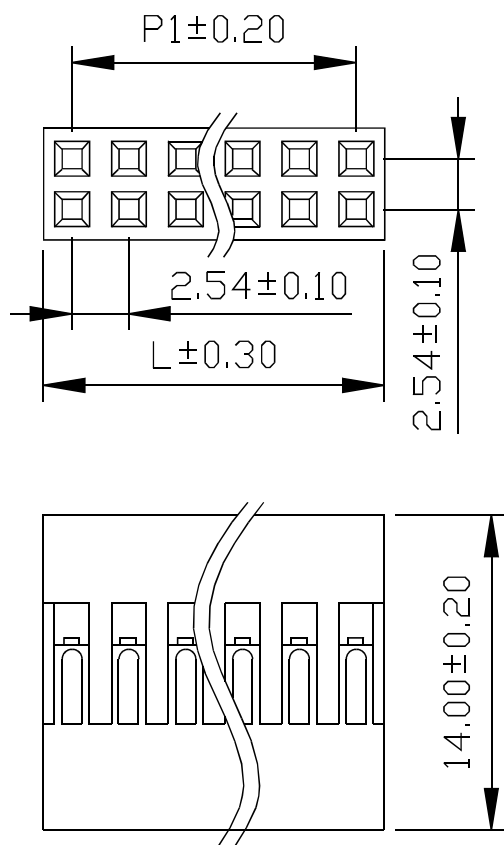

Part No.: PIN24184 Jumper

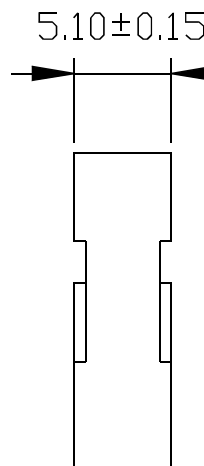
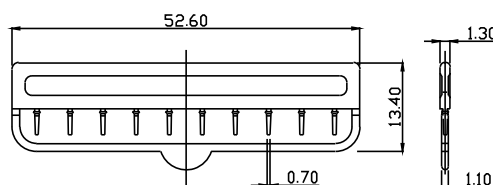

Part No.	POS.	L	P1	Pack.	Part No.	POS.	L	P1	Pack.	Part No.	POS.	L	P1	Pack.
PD241842	2X2	5.08	2.54	1000	PD2418415	2X15	38.10	35.56	500	PD2418428	2X28	71.12	68.58	250
PD241843	2X3	7.62	5.08	1000	PD2418416	2X16	40.64	38.10	500	PD2418429	2X29	73.66	71.12	250
PD241844	2X4	10.16	7.62	1000	PD2418417	2X17	43.18	40.64	500	PD2418430	2X30	76.20	73.66	500
PD241845	2X5	12.70	10.16	1000	PD2418418	2X18	45.72	43.18	500	PD2418431	2X31	78.74	76.20	500
PD241846	2X6	15.24	12.76	1000	PD2418419	2X19	48.26	45.72	500	PD2418432	2X32	81.28	78.74	500
PD241847	2X7	17.78	15.24	1000	PD2418420	2X20	50.80	48.26	250	PD2418433	2X33	83.82	81.28	500
PD241848	2X8	20.32	17.78	1000	PD2418421	2X21	53.34	50.80	250	PD2418434	2X34	86.36	83.82	500
PD241849	2X9	22.86	20.32	1000	PD2418422	2X22	55.88	53.34	250	PD2418435	2X35	88.90	86.36	500
PD2418410	2X10	25.40	22.86	500	PD2418423	2X23	58.42	55.88	250	PD2418436	2X36	91.44	88.90	500
PD2418411	2X11	27.94	25.40	500	PD2418424	2X24	60.96	58.42	250	PD2418437	2X37	93.98	91.44	500
PD2418412	2X12	30.48	27.94	500	PD2418425	2X25	63.50	60.96	250	PD2418438	2X38	96.52	93.98	500
PD2418413	2X13	33.02	30.48	500	PD2418426	2X26	66.04	63.50	250	PD2418439	2X39	99.06	96.52	500
PD2418414	2X14	35.56	33.02	500	PD2418427	2X27	68.58	66.04	250	PD2418440	2X40	101.60	99.06	250

Unit: mm

24184 Wire to Board Connectors



TERMINAL

Part No.: **24184BS-2 24184BS-00**

產品編號

Thickness: 0.20mm

銅板厚度

Material: Brass

材質 黃銅

Surface Treatment: Tin-plated (-2) Gold-flash (-00)

表面處理 鍍錫 鍍金

Applicable Wire: AWG# 24~28

適用電線

Insulation O.D.: 1.20~1.50mm

線皮外徑

Suitable Housing: P241841~P2418440 PD241841~PD2418440

配合塑膠

Suitable Connector: M241841~M2418440 MD241841~MD2418440

配合公座

M241841R~M2418440R MD241841R~MD2418440R

MS2418441~MS2418440 MDS241841~MDS2418440

MDF241842R~MDF2418440R

Packing: 10,000PCS(Reel)

包裝數量

PERFORMANCE

Electrical Rating: AC/DC 250V 3A

額定電壓電流

Insulation Resistance: 1000MΩ min.

絕緣阻抗

Withstanding Voltage: 1000V AC/minute

耐電壓

Temperature Range: -25°C~+85°C

適用溫度



2.54mm

