

24216

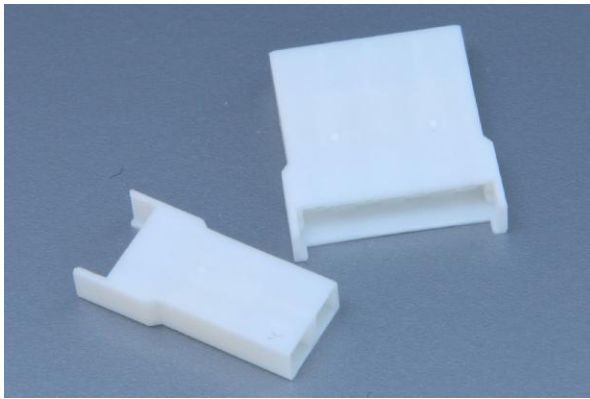

Pitch 4.0mm Wire to Wire Connectors



PERFORMANCE

Electrical Rating: AC/DC 600V 1A

額定電壓電流

Insulation Resistance: 1000MΩ min.

絕緣阻抗

Withstanding Voltage: 1800V AC/minute

耐電壓

Temperature Range: -25°C~+85°C

適用溫度



HOUSING

Part No.: P24216P3~P24216P7

產品編號

Material: Nylon 94V-0

材質

Suitable Contact: 24216PS-2

配合端子

Acceptable Wire: AWG# 22~28

適用電線

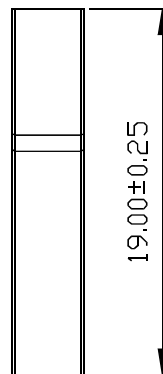
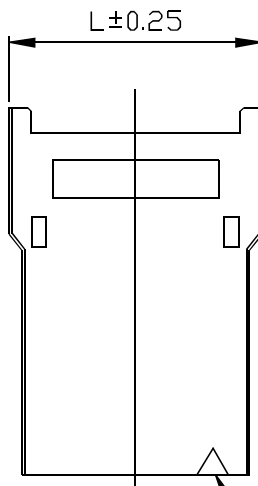
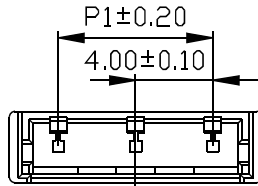
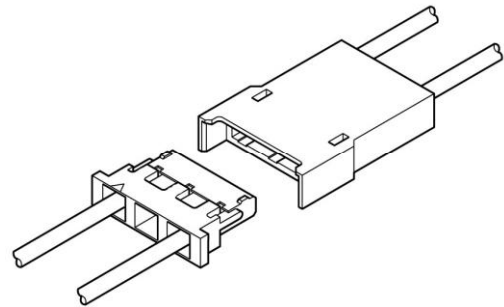

Circuit 1

Unit: mm

Part No.	POS.	L	P1	Pack.
P24216P3	3	9.10	4.00	500
P24216P5	5	13.10	8.00	500
P24216P7	7	17.10	12.00	1000

Behave in conformity with continual product development policy, SinSheng (STM) reserves the right of specification changing of contents described in this catalogue at any time and without prior notice. Please contact the sales department nearby for most updated information.
由於產品持續開發的政策, 信盛(STM)保留隨時變更本目錄所述之規格且不需提前通知的權利。請連繫業務處查詢最新的產品資訊。

4.0mm

24216 Wire to Wire Connectors



TERMINAL

Part No.: 24216PS-2

產品編號

Thickness: 0.20mm

銅板厚度

Material: Phosphor Bronze

材質 磷青銅

Surface Treatment: Tin-plated

表面處理 鍍錫

Acceptable Wire: AWG# 22-28

適用電線

Insulation O.D.: 1.60~2.40mm

線皮外徑

Suitable Housing: P24216P3~P24216P7

配合塑膠

Packing: 5,000PCS(Reel)

包裝數量

PERFORMANCE

Electrical Rating: AC/DC 600V 1A

額定電壓電流

Insulation Resistance: 1000MΩ min.

絕緣阻抗

Withstanding Voltage: 1800V AC/minute

耐電壓

Temperature Range: -25°C~+85°C

適用溫度

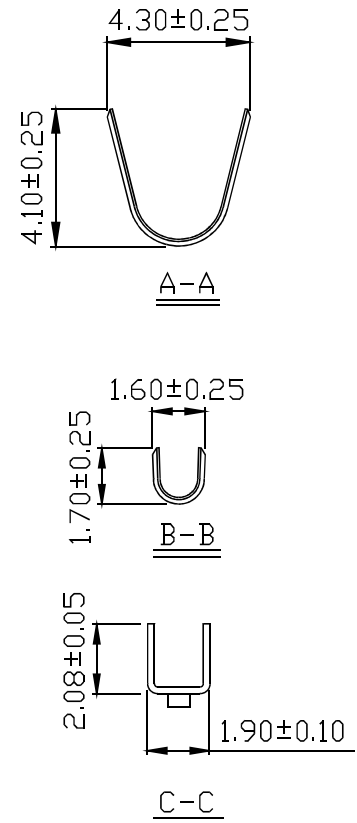
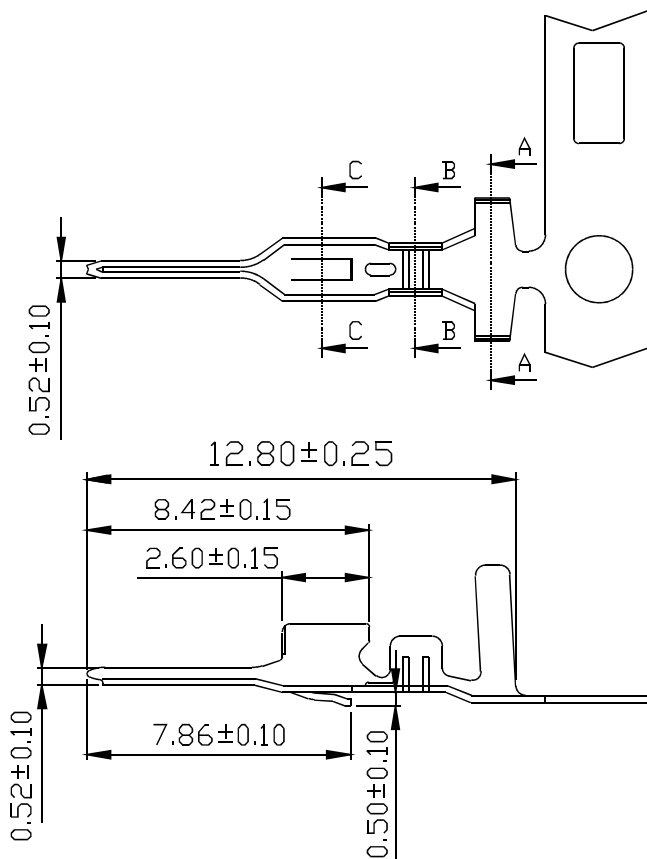

4.0mm