

2428

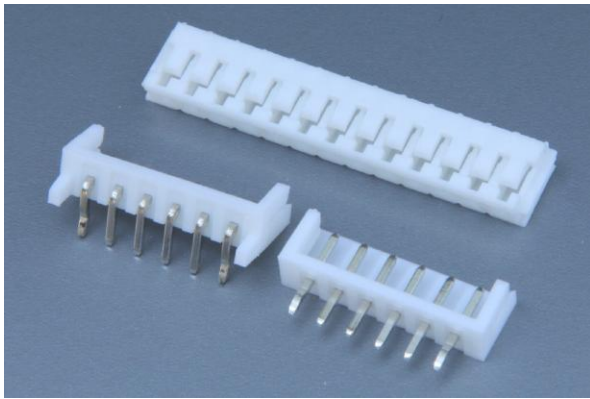

Pitch 2.5mm Wire to Board Connectors



PERFORMANCE

Electrical Rating: AC/DC 250V 3A
 額定電壓電流
 Insulation Resistance: 1000MΩ min.
 絕緣阻抗
 Withstanding Voltage: 800V AC/minute
 耐電壓
 Temperature Range: -25°C~+85°C
 適用溫度



CONNECTOR - Top Entry

Part No.: M24282~M242815

產品編號

Material: Housing: Nylon 94V-0

材質 塑膠座

Contact Pin: Brass, Tin-plated
 接觸針 黃銅 鍍錫

Suitable Contact: 2428PS-2

配合端子

Suitable Housing: P24282~P242815

配合塑膠

Applicable Wire: AWG# 22~30

適用電線

Square Contact Pin: 0.64±0.02mm

方型接觸針

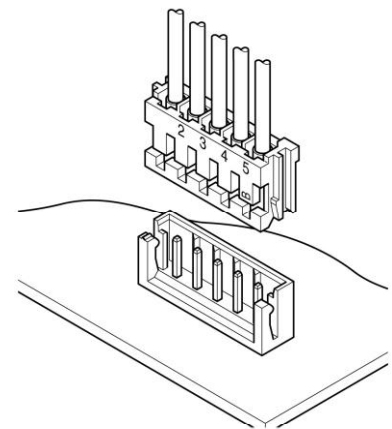

2.5mm

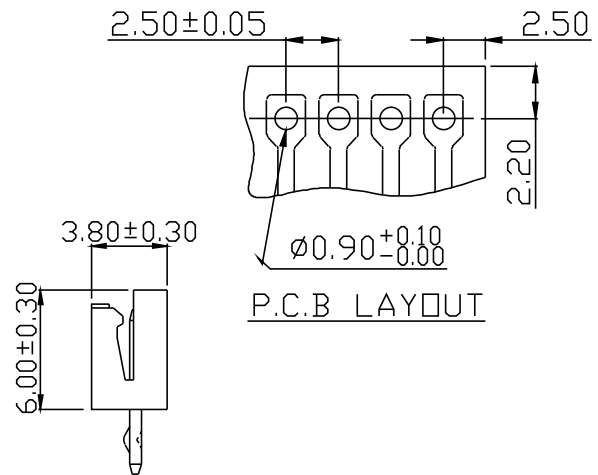
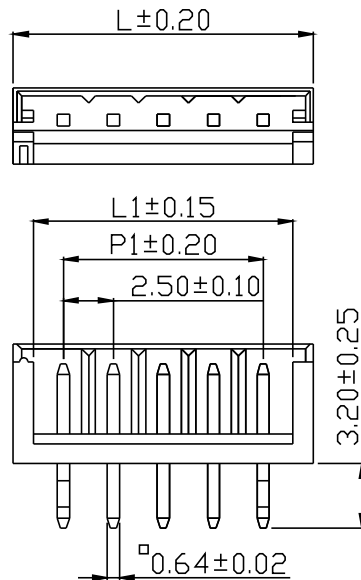

Unit: mm

PartNo.	POS.	L	L1	P1	Pack.
M24282	2	7.50	5.50	2.50	1000
M24283	3	10.00	8.00	5.00	1000
M24284	4	12.50	10.50	7.50	1000
M24285	5	15.00	13.00	10.00	1000
M24286	6	17.50	15.50	12.50	1000
M24287	7	20.00	18.00	15.00	500
M24288	8	22.50	20.50	17.50	500

PartNo.	POS.	L	L1	P1	Pack.
M24289	9	25.00	23.00	20.00	500
M242810	10	27.50	25.50	22.50	500
M242811	11	30.00	28.00	25.00	500
M242812	12	32.50	30.50	27.50	500
M242813	13	35.00	33.00	30.00	500
M242814	14	37.50	35.50	32.50	500
M242815	15	40.00	38.00	35.00	500

Behave in conformity with continual product development policy, SinSheng (STM) reserves the right of specification changing of contents described in this catalogue any time and without prior notice. Please contact the sales department nearby for most updated information.
 由於產品持續開發的政策, 信盛(STM)保留隨時變更本目錄所述之規格且不需提前通知的權利。請連繫業務處查詢最新的產品資訊。

2428 Wire to Board Connectors



CONNECTOR - Side Entry

Part No.: M24282R~M242815R

產品編號

Material: Housing: Nylon 94V-0

材質

塑膠座

Contact Pin: Brass, Tin-plated

接觸針

黃銅, 鍍錫

Suitable Contact: 2428PS-2

配合端子

Suitable Housing: P24282~P242815

配合塑膠

Applicable Wire: AWG# 22~30

適用電線

Square Contact Pin: 0.64±0.02mm

方型接觸針

PERFORMANCE

Electrical Rating: AC/DC 250V 3A

額定電壓電流

Insulation Resistance: 1000MΩ min.

絕緣阻抗

Withstanding Voltage: 800V AC/minute

耐電壓

Temperature Range: -25°C~+85°C

適用溫度

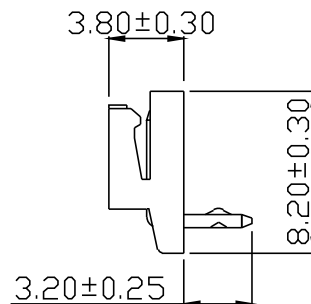
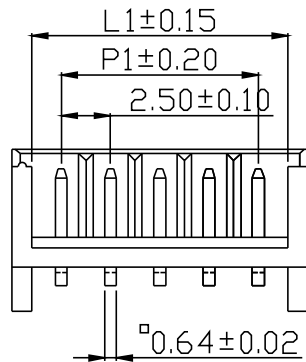
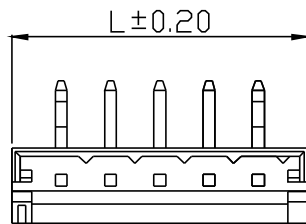
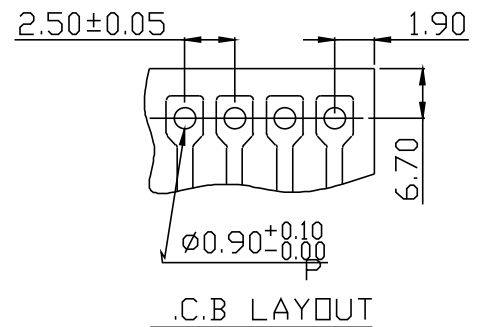

2.5mm

Unit: mm

PartNo.	POS.	L	L1	P1	Pack.	PartNo.	POS.	L	L1	P1	Pack.
M24282R	2	7.50	5.50	2.50	1000	M24289R	9	25.00	23.00	20.00	500
M24283R	3	10.00	8.00	5.00	1000	M242810R	10	27.50	25.50	22.50	500
M24284R	4	12.50	10.50	7.50	1000	M242811R	11	30.00	28.00	25.00	500
M24285R	5	15.00	13.00	10.00	1000	M242812R	12	32.50	30.50	27.50	500
M24286R	6	17.50	15.50	12.50	1000	M242813R	13	35.00	33.00	30.00	500
M24287R	7	20.00	18.00	15.00	500	M242814R	14	37.50	35.50	32.50	500
M24288R	8	22.50	20.50	17.50	500	M242815R	15	40.00	38.00	35.00	500

HOUSING

Part No.: P24282~P242815

產品編號

Material: Nylon 94V-0

材質

Suitable Contact: 2428PS-2

配合端子

Suitable Connector: M24282~M242815

配合公座

M24282R~M242815R

Applicable Wire: AWG#22~30

適用電線

PERFORMANCE

Electrical Rating: AC/DC 250V 3A

額定電壓電流

Insulation Resistance: 1000MΩ min.

絕緣阻抗

Withstanding Voltage: 800V AC/minute

耐電壓

Temperature Range: -25°C~+85°C

適用溫度

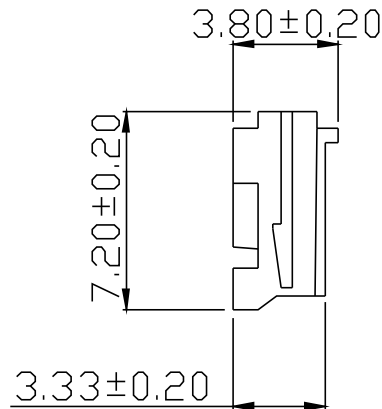
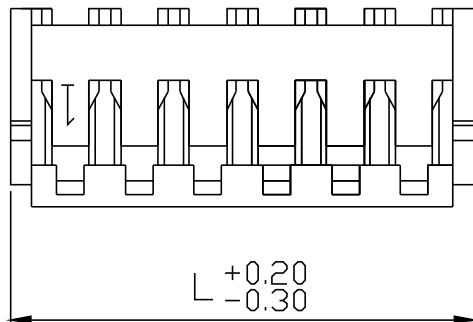
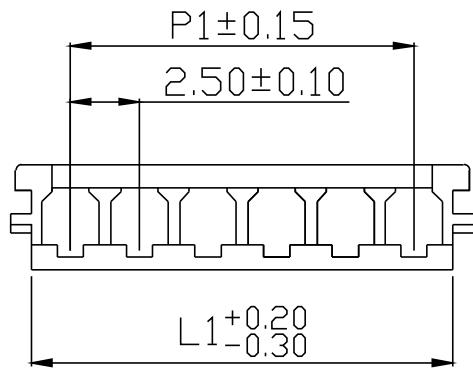

2.5mm

Unit: mm

PartNo.	POS.	L	L1	P1	Pack.
P24282	2	6.90	5.30	2.50	1000
P24283	3	9.40	7.80	5.00	1000
P24284	4	11.90	10.30	7.50	1000
P24285	5	14.40	12.80	10.00	1000
P24286	6	16.90	15.30	12.50	1000
P24287	7	19.40	17.80	15.00	500
P24288	8	21.90	20.30	17.50	500

PartNo.	POS.	L	L1	P1	Pack.
P24289	9	24.40	22.80	20.00	500
P242810	10	26.90	25.30	22.50	500
P242811	11	29.40	27.80	25.00	500
P242812	12	31.90	30.30	27.50	500
P242813	13	34.40	32.80	30.00	500
P242814	14	36.90	35.30	32.50	500
P242815	15	39.40	37.80	35.00	500

2428 Wire to Board Connectors

TERMINAL

Part No.: 2428PS-2

產品編號

Thickness: 0.20mm

銅板厚度

Material: Phosphor Bronze

材質 磷青銅

Surface Treatment: Tin-plated

表面處理 鍍錫

Applicable Wire: AWG# 22-30

適用電線

Insulation O.D.: 0.71~1.70mm

線皮外徑

Suitable Housing: P24282~P242815

配合塑膠

Suitable Connector: M24282~M242815

配合公座

M24282R~M242815R

Packing: 10,000PCS(Reel)

包裝數量

PERFORMANCE

Electrical Rating: AC/DC 250V 3A

額定電壓電流

Insulation Resistance: 1000MΩ min.

絕緣阻抗

Withstanding Voltage: 800V AC/minute

耐電壓

Temperature Range: -25°C~+85°C

適用溫度



2.5mm

